

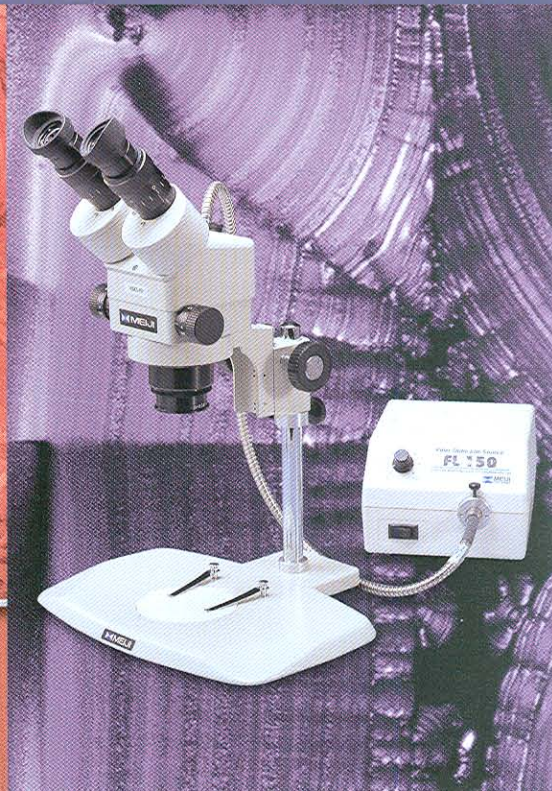

# STEREO MICROSCOPES

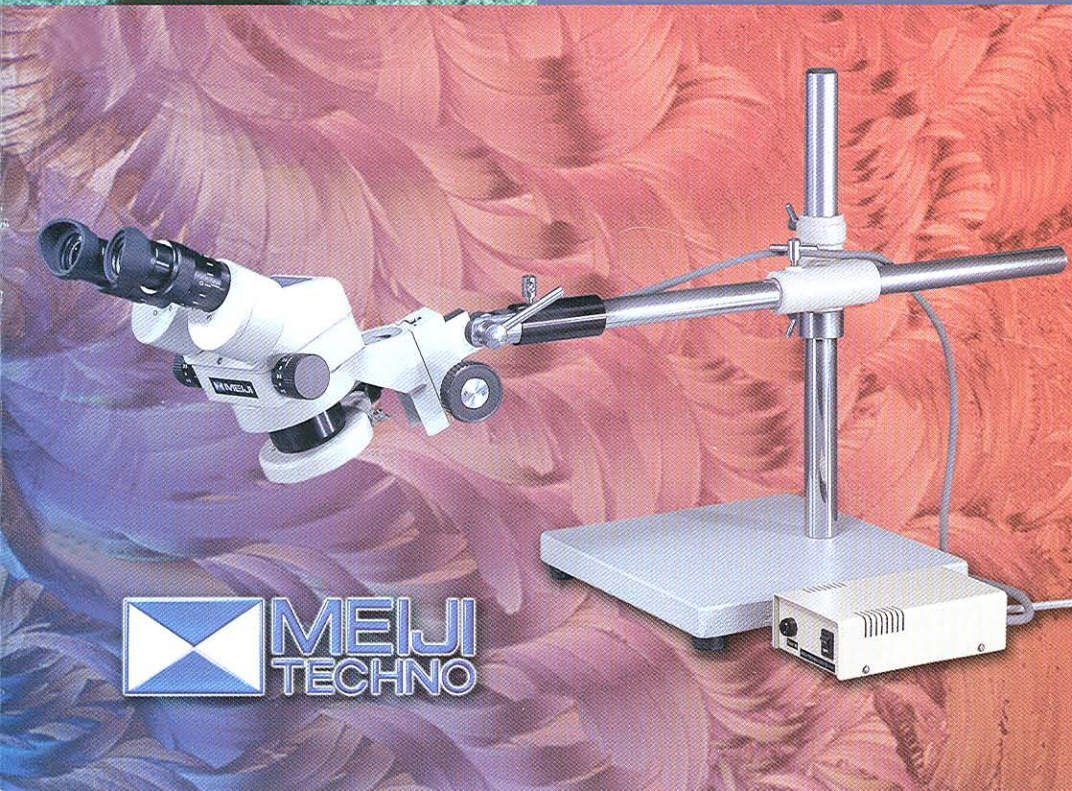

# EM Series





# TABLE OF CONTENTS

EMZ-5 Zoom Stereo Microscopes .....page 2

EMZ-5TR Trinocular Zoom Stereo Microscopes .....page 3

EMZ Zoom Microscope Bodies .....page 4-8

EMT Turret and Fixed Microscope Bodies .....page 9-10

EMX Long Working Distance Turret Stereo Body .....page 11

Configuration Samples .....page 10-11

Eyepieces and Eyepiece Accessories .....page 12

Auxiliary Objective Lenses .....page 13

Focusing Blocks .....page 14-15

Pole Type Stands .....page 16-18

Rigid Arm Stands .....page 19-20

Stands With Extended Work Surface .....page 21

Universal Boom Stands .....page 22

Articulated Arm, Clamp Boom, Extended Work Surface Stand .....page 23

Stages .....page 24-25

Accessories .....page 25-26

Configuration Samples .....page 27

Illumination and Accessories .....page 28-29

Cameras for Video Microscopy .....page 30

Video "C" Mounts .....page 31

Photomicroscopy Accessories .....page 32

Digital camera adapters .....page 32-33

EMZ Optical Data .....page 34

EMF, EMT, EMTR and EMX Optical Data .....page 35

System Diagram for Zoom Models .....page 36-37

System Diagram for EMF, EMT, EMTR, and EMX .....page 38-39

System Diagram for Special Stands .....page 40

System Diagram for Video Microscopy .....page 41

System Diagram for Photomicroscopy .....page 41

## EMZ Series

# ZOOM STEREO MICROSCOPES

### EMZ-5 ZOOM STEREO BODY

- Crisp, high resolution, precision optics provide an excellent, erect, unreversed stereoscopic image.
- Rugged all metal body designed to last a lifetime.
- Zoom Range: 0.7X to 4.5X
- Zoom Ratio: 6.5:1
- Ergonomically positioned bilateral zoom controls.
- Binocular eyetubes inclined at 45° for fatigue free viewing.
- Total magnification range available with auxillary lenses and eyepieces: 2.1X to 270X.
- Dual dioptic adjustment ( $\pm 5$  diopters) allows the specimen to remain in focus throughout the entire zoom magnification range.
- Interpupillary distance adjustment from 54mm to 75mm.
- Binocular body can be rotated a full 360° and locked in any position.
- Standard working distance 93mm.
- Working distance with optional auxillary lenses: 34mm to 251mm.



EMZ-5 with MA502 SWF10X

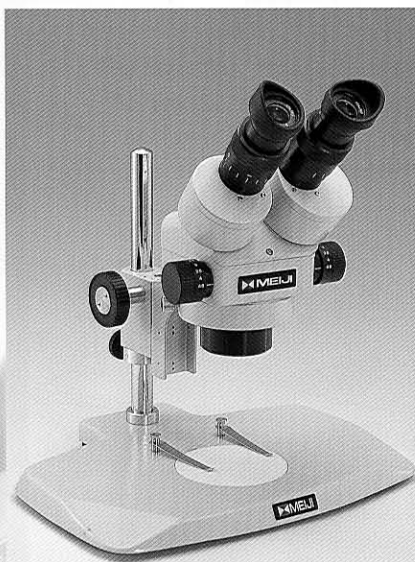

EMZ-5 on PK Stand with MA502 SWF10X eyepieces

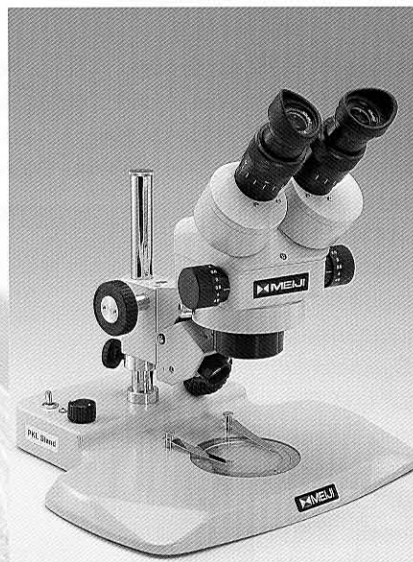

EMZ-5 on PKL Stand with MA502 SWF10X eyepieces

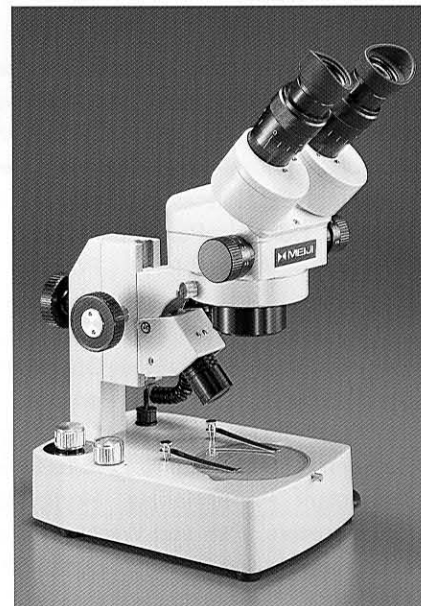

EMZ-5 on ABE Stand with MA502 SWF10X eyepieces

## EMZ-5TR ZOOM STEREO BODY

- Trinocular zoom body for use in photographic and video applications. When the beamsplitter is engaged 100% of the light from the left optical path is directed to the phototube. The image can still be viewed through the right eyetube.
- Crisp, high resolution, precision optics provide an excellent, erect, unreversed stereoscopic image.
- Rugged all metal body designed to last a lifetime.
- Zoom Range: 0.7X to 4.5X
- Zoom Ratio: 6.5:1
- Ergonomically positioned bilateral zoom controls.
- Binocular eyetubes inclined at 45° for fatigue free viewing.
- Total magnification range available with auxiliary lenses and eyepieces: 2.1X to 270X.
- Dual dioptic adjustment ( $\pm 5$  diopters) allows the specimen to remain in focus throughout the entire zoom magnification range.
- Interpupillary distance adjustment from 54mm to 75mm.
- Trinocular body can be rotated a full 360° and locked in any position.
- Standard working distance 93mm.
- Working distance with optional auxiliary lenses: 34mm to 251mm.



EMZ-5TR with MA502 SWF10X

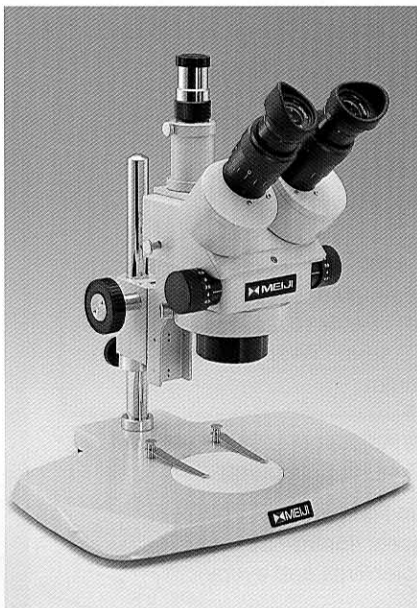

EMZ-5TR on PK Stand with MA502 SWF10X eyepieces

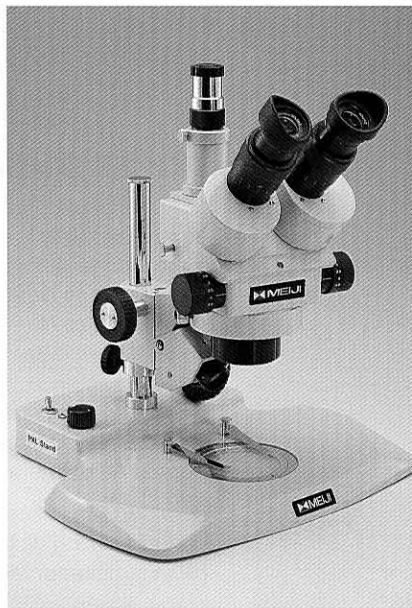

EMZ-5TR on PKL Stand with MA502 SWF10X eyepieces

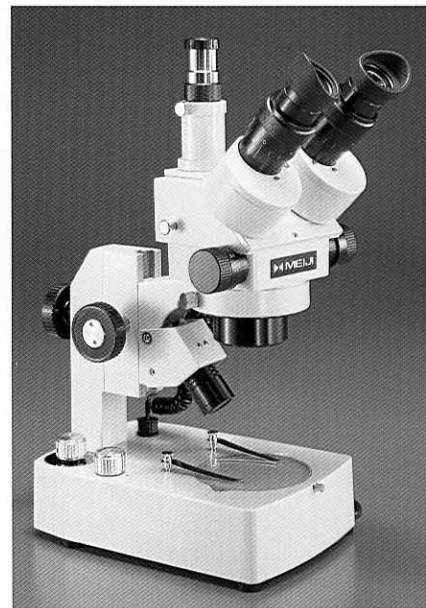

EMZ-5TR on ABE Stand with MA502 SWF10X eyepieces



# ZOOM STEREO MICROSCOPES



**EMZ-5** with MA502 SWF10X eyepieces

## **EMZ-5 ZOOM STEREO BODY**

Body: Binocular, rotatable 360°  
Zoom Ratio: 6.5:1  
Zoom Range: 0.7X to 4.5X  
Zoom Control: Dual, graduated, bilateral mount.  
Magnification: 7X - 45X (With 10X eyepieces)  
Field of view: 32mm - 5.1mm (With 10X eyepieces)  
Working Distance: 93mm, Eyetube Inclination: 45°  
Interpupillary Distance Adjustment: 54mm - 75mm  
Dioptric Adjustment: Dual ( $\pm 5$  diopters)

Extended Magnification Range : 2.1X - 270X  
Extend working distances: 34mm - 251mm  
(With supplemental objectives and eyepieces)

## **EMZ-5D ZOOM STEREO BODY WITH DETENT**



**EMZ-5TR** with MA502 SWF10X eyepieces

## **EMZ-5TR ZOOM STEREO BODY**

Body: Trinocular, rotatable 360°  
Zoom Ratio: 6.5:1  
Zoom Range: 0.7X to 4.5X  
Zoom Control: Dual, graduated, bilateral mount.  
Magnification: 7X - 45X (With 10X eyepieces)  
Field of view: 32mm - 5.1mm (With 10X eyepieces)  
Working Distance: 93mm, Eyetube Inclination: 45°  
Interpupillary Distance Adjustment: 54mm - 75mm  
Dioptric Adjustment: Dual ( $\pm 5$  diopters)

Extended Magnification Range : 2.1X - 270X  
Extend working distances: 34mm - 251mm  
(With supplemental objectives and eyepieces)

## **EMZ-5TRD ZOOM STEREO BODY WITH DETENT**



**EMZ-10** with MA502 SWF10X eyepieces

## **EMZ-10 ZOOM STEREO BODY**

Body: Binocular, rotatable 360°  
Zoom Ratio: 6.5:1  
Zoom Range: 0.7X to 4.5X  
Zoom Control: Dual, graduated, bilateral mount.  
Magnification: 7X - 45X (With 10X eyepieces)  
Field of view: 32mm - 5.1mm (With 10X eyepieces)  
Working Distance: 110mm  
Eyeteube Inclination: 45°  
Interpupillary Distance Adjustment: 54mm - 75mm  
Dioptric Adjustment: Dual ( $\pm 5$  diopters)

Extended Magnification Range : 2.1X - 270X  
Extend working distances: 45mm - 332mm  
(With supplemental objectives and eyepieces)





EMZ-2 with MA502 SWF10X eyepieces

### EMZ-2 ZOOM STEREO BODY

Body: Binocular, rotatable 360°  
 Zoom Ratio: 6.5:1  
 Zoom Range: 0.7X to 4.5X  
 Zoom Control: Graduated knurled ring  
 Magnification: 7X - 45X (With 10X eyepieces)  
 Field of view: 32mm - 5.1mm (With 10X eyepieces)  
 Working Distance: 93mm  
 Eyetube Inclination: 45°  
 Interpupillary Distance Adjustment: 54mm - 75mm  
 Dioptic Adjustment: Dual ( $\pm 5$  diopters)

Extended Magnification Range : 2.1X - 270X  
 Extend working distances: 34mm - 251mm  
 (With supplemental objectives and eyepieces)



EMZ-2TR with MA502 SWF10X eyepieces

### EMZ-2TR ZOOM STEREO BODY

Body: Trinocular, rotatable 360°  
 Zoom Ratio: 6.5:1  
 Zoom Range: 0.7X to 4.5X  
 Zoom Control: Graduated knurled ring  
 Magnification: 7X - 45X (With 10X eyepieces)  
 Field of view: 32mm - 5.1mm (With 10X eyepieces)  
 Working Distance: 93mm  
 Eyetube Inclination: 45°  
 interpupillary Distance Adjustment: 54mm - 75mm  
 Dioptic Adjustment: Dual ( $\pm 5$  diopters)

Extended Magnification Range : 2.1X - 270X  
 Extend working distances: 34mm - 251mm  
 (With supplemental objectives and eyepieces)



Z-7100 with MA502 SWF10X eyepieces

### Z-7100 ZOOM STEREO BODY

Body: Binocular, rotatable 360°  
 Zoom Ratio: 6.5:1  
 Zoom Range: 0.7X to 4.5X  
 Zoom Control: Dual, graduated, bilateral mount.  
 Magnification: 7X - 45X (With 10X eyepieces)  
 Field of view: 32mm - 5.1mm (With 10X eyepieces)  
 Working Distance: 110mm  
 Eyetube Inclination: 90°  
 Interpupillary Distance Adjustment: 54mm - 75mm  
 Dioptic Adjustment: Dual ( $\pm 5$  diopters)

Extended Magnification Range : 2.1X - 270X  
 Extend working distances: 45mm - 332mm  
 (With supplemental objectives and eyepieces)



# ZOOM STEREO MICROSCOPES



EMZ-8U with MA502 SWF10X eyepieces



EMZ-8TR with MA502 SWF10X eyepieces



EMZ-8TRU with MA502 SWF10X eyepieces

## EMZ-8U ZOOM STEREO BODY WITH INLET FOR FIBER LIGHT GUIDE

Body: Binocular, rotatable 360°  
Zoom Ratio: 6.5:1  
Zoom Range: 0.7X to 4.5X  
Zoom Control: Dual, graduated, bilateral mount.  
Magnification: 7X - 45X (With 10X eyepieces)  
Field of view: 32mm - 5.1mm (With 10X eyepieces)  
Working Distance: 104mm, Eyetube Inclination: 45°  
Interpupillary Distance Adjustment: 54mm - 75mm  
Dioptric Adjustment: Dual ( $\pm 5$  diopters)

Extended Magnification Range : 2.45X - 202.5X  
Extend working distances: 57mm - 250mm  
(With supplemental objectives and eyepieces)

## EMZ-8UD ZOOM STEREO BODY WITH DETENT

## EMZ-8TR ZOOM STEREO BODY

**Benefits: Direct light to all three viewing ports simultaneously**

Body: Trinocular, rotatable 360°  
Zoom Ratio: 6.5:1  
Zoom Range: 0.7X to 4.5X  
Zoom Control: Dual, graduated, bilateral mount.  
Magnification: 7X - 45X (With 10X eyepieces)  
Field of view: 32mm - 5.1mm (With 10X eyepieces)  
Working Distance: 104mm, Eyetube Inclination: 45°  
Interpupillary Distance Adjustment: 54mm - 75mm  
Dioptric Adjustment: Dual ( $\pm 5$  diopters)

Extended Magnification Range : 2.45X - 202.5X  
Extend working distances: 57mm - 250mm  
(With supplemental objectives and eyepieces)

## EMZ-8TRD ZOOM STEREO BODY WITH DETENT

## EMZ-8TRU ZOOM STEREO BODY WITH INLET FOR FIBER LIGHT GUIDE

**Benefits: Direct light to all three viewing ports simultaneously**

Body: Trinocular, rotatable 360°  
Zoom Ratio: 6.5:1  
Zoom Range: 0.7X to 4.5X  
Zoom Control: Dual, graduated, bilateral mount.  
Magnification: 7X - 45X (With 10X eyepieces)  
Field of view: 32mm - 5.1mm (With 10X eyepieces)  
Working Distance: 104mm, Eyetube Inclination: 45°  
Interpupillary Distance Adjustment: 54mm - 75mm  
Dioptric Adjustment: Dual ( $\pm 5$  diopters)

Extended Magnification Range : 2.45X - 202.5X  
Extend working distances: 57mm - 250mm  
(With supplemental objectives and eyepieces)





**EMZ-12** with MA502 SWF10X eyepieces



**EMZ-12TR** with MA502 SWF10X eyepieces

### **EMZ-12 ZOOM STEREO BODY WITH INLET FOR FIBER LIGHT GUIDE**

Body: Binocular, rotatable 360°  
Zoom Ratio: 6.25:1  
Zoom Range: 0.4X to 2.5X  
Zoom Control: Graduated knurled ring  
Magnification: 4X - 25X (With 10X eyepieces)  
Field of view: 57mm - 9.2mm (With 10X eyepieces)  
Working Distance: 185mm, Eyetube Inclination: 45°  
Interpupillary Distance Adjustment: 54mm - 75mm  
Dioptric Adjustment: Dual ( $\pm 5$  diopters)

Extended Magnification Range : 2.28X - 75X  
Extend working distances: 185mm - 300mm  
(With supplemental objectives and eyepieces)

### **EMZ-12D ZOOM STEREO BODY WITH DETENT**

### **EMZ-12TR ZOOM STEREO BODY WITH INLET FOR FIBER LIGHT GUIDE**

Body: Trinocular, rotatable 360°  
Zoom Ratio: 6.25:1  
Zoom Range: 0.4X to 2.5X  
Zoom Control: Graduated knurled ring  
Magnification: 4X - 25X (With 10X eyepieces)  
Field of view: 57mm - 9.2mm (With 10X eyepieces)  
Working Distance: 185mm, Eyetube Inclination: 45°  
interpupillary Distance Adjustment: 54mm - 75mm  
Dioptric Adjustment: Dual ( $\pm 5$  diopters)

Extended Magnification Range : 2.28X - 75X  
Extend working distances: 185mm - 300mm  
(With supplemental objectives and eyepieces)

### **EMZ-12TRD ZOOM STEREO BODY WITH DETENT**



## EMZ Series

# ZOOM STEREO MICROSCOPES



EMZ-13 with MA502 SWF10X eyepieces

### EMZ-13 ZOOM STEREO BODY

Body: Binocular, rotatable 360°  
Zoom Ratio: 7:1  
Zoom Range: 1X to 7X  
Zoom Control: Dual, graduated, bilateral mount.  
Magnification: 10X - 70X (With 10X eyepieces)  
Field of view: 23mm - 3.2mm (With 10X eyepieces)  
Working Distance: 90mm, Eyetube Inclination: 45°  
Interpupillary Distance Adjustment: 54mm - 75mm  
Dioptric Adjustment: Dual ( $\pm 5$  diopters)

Extended Magnification Range : 3X - 420X  
Extend working distances: 32mm - 230mm  
(With supplemental objectives and eyepieces)

### EMZ-13D ZOOM STEREO BODY WITH DETENT

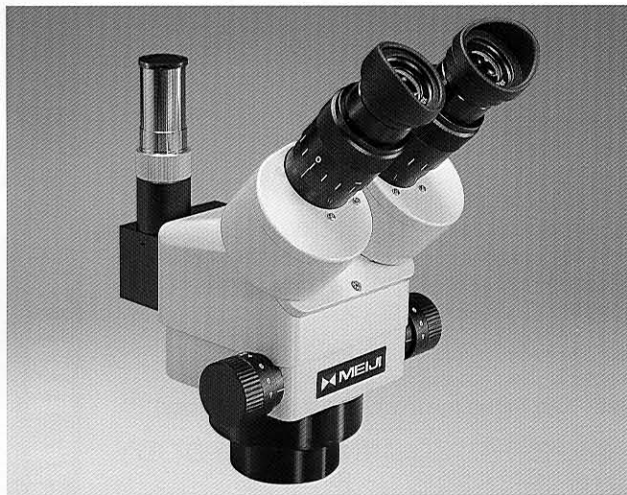

EMZ-13TR with MA502 SWF10X eyepieces

### EMZ-13TR ZOOM STEREO BODY

Body: Trinocular, rotatable 360°  
Zoom Ratio: 7:1  
Zoom Range: 1X to 7X  
Zoom Control: Dual, graduated, bilateral mount.  
Magnification: 10X - 70X (With 10X eyepieces)  
Field of view: 23mm - 3.2mm (With 10X eyepieces)  
Working Distance: 90mm, Eyetube Inclination: 45°  
Interpupillary Distance Adjustment: 54mm - 75mm  
Dioptric Adjustment: Dual ( $\pm 5$  diopters)

Extended Magnification Range : 3X - 420X  
Extend working distances: 32mm - 230mm  
(With supplemental objectives and eyepieces)

### EMZ-13TRD ZOOM STEREO BODY WITH DETENT



# TURRET-TYPE STEREO MICROSCOPES



**EMT-1**  
with MA502 SWF10X eyepieces

**EMTR-1**  
with MA502 SWF10X eyepieces

## EMT-1 & EMTR-1 TURRET STEREO BODY

Body: Binocular or trinocular, rotatable 360°  
 Paired Objectives: 1X, 2X  
 Magnification: 10X, 20X (With 10X eyepieces)  
 Field of view: 23mm, 11.5mm (With 10X eyepieces)  
 Working Distance: 108mm  
 Eyetube Inclination: 45°  
 Interpupillary Distance Adjustment: 54mm - 75mm  
 Dioptic Adjustment: Left eyetube  
 Extended Magnification Range : 10X - 60X  
 Extend working distances: None



**EMT-2**  
with MA502 SWF10X eyepieces

**EMTR-2**  
with MA502 SWF10X eyepieces

## EMT-2 & EMTR-2 TURRET STEREO BODY

Body: Binocular or trinocular, rotatable 360°  
 Paired Objectives: 1X, 3X  
 Magnification: 10X, 30X (With 10X eyepieces)  
 Field of view: 23mm, 7.6mm (With 10X eyepieces)  
 Working Distance: 81mm  
 Eyetube Inclination: 45°  
 Interpupillary Distance Adjustment: 54mm - 75mm  
 Dioptic Adjustment: Left eyetube  
 Extended Magnification Range : 5X - 180X  
 Extend working distances: 21mm - 108mm  
 (With supplemental objectives and eyepieces)



**EMT-3**  
with MA502 SWF10X eyepieces

**EMTR-3**  
with MA502 SWF10X eyepieces

## EMT-3 & EMTR-3 TURRET STEREO BODY

Body: Binocular or trinocular, rotatable 360°  
 Paired Objectives: 2X, 4X  
 Magnification: 20X, 40X (With 10X eyepieces)  
 Field of view: 11.5mm, 5.7mm (With 10X eyepieces)  
 Working Distance: 63mm  
 Eyetube Inclination: 45°  
 Interpupillary Distance Adjustment: 54mm - 75mm  
 Dioptic Adjustment: Left eyetube  
 Extended Magnification Range : 10X - 240X  
 Extend working distances: 22mm - 108mm  
 (With supplemental objectives and eyepieces)



## TURRET-TYPE

# STEREO MICROSCOPES

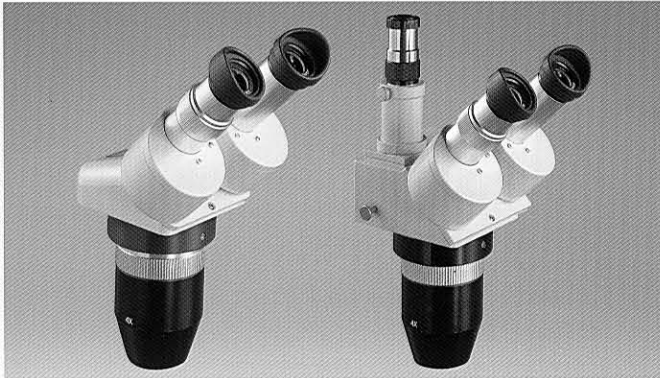

**EMT-4**  
with MA502 SWF10X eyepieces

**EMTR-4**  
with MA502 SWF10X eyepieces

### EMT-4 & EMTR-4 TURRET STEREO BODIES

Body: Binocular or trinocular, rotatable 360°  
 Paired Objectives: 1X, 4X  
 Magnification: 10X, 40X (With 10X eyepieces)  
 Field of view: 23mm, 5.7mm (With 10X eyepieces)  
 Working Distance: 63mm  
 Eyetube Inclination: 45°  
 Interpupillary Distance Adjustment: 54mm - 75mm  
 Dioptic Adjustment: Left eyetube

Extended Magnification Range : 5X - 240X  
 Extend working distances: 22mm-108mm

## FIXED-OBJECTIVE TYPE

# STEREO MICROSCOPES



EMF-1, EMF-2 with MA502 SWF10X eyepieces

### EMF-1, EMF-2 FIXED-OBJECTIVE STEREO BODY

	EMF-1	EMF-2
Body	Binocular rotatable 360°	
Paired Objective	1X	2X
Magnification (with 10X eyepieces)	10X	20X
Field of view	23mm	11.5mm
Working Distance	108mm	
Eyetube Inclination	45°	
Interpupillary Distance Adjustment	54mm - 75mm	
Dioptic Adjustment	Left eyetube	
Extended Magnification Range (with optional eyepieces)	5X - 30X	10X - 60X

# CONFIGURATION SAMPLES

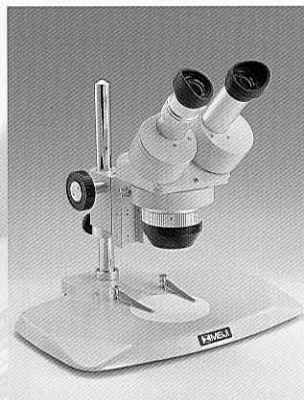

EMF-2 / SWF10X / PK

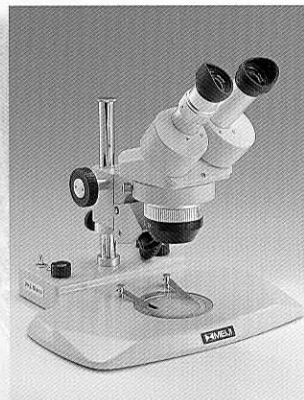

EMT-1 / SWF10X / PKL



EMTR-2 / SWF10X / PBH

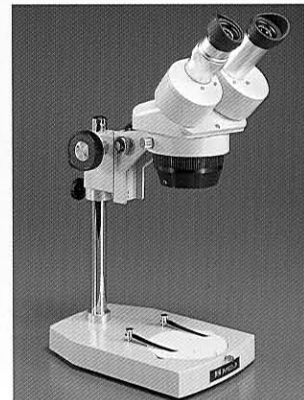

EMX-1 / SWF10X / PX



# LONG WORKING DISTANCE TURRET STEREO



EMX-1 with MA502 SWF10X eyepieces

## EMX-1 TURRET STEREO BODIES

Body: Binocular, rotatable 360°  
 Paired Objectives: 0.5X, 1X  
 Magnification: 5X, 10X (With 10X eyepieces)  
 Field of view: 46mm, 23mm (With 10X eyepieces)  
 Working Distance: 225mm  
 Eyetube Inclination: 45°  
 Interpupillary Distance Adjustment: 54mm - 75mm  
 Dioptic Adjustment: Left eyetube  
 Extended Magnification Range : 5X - 30X  
 Extend working distances: 300mm  
 (With supplemental objectives and eyepieces)

# CONFIGURATION SAMPLES

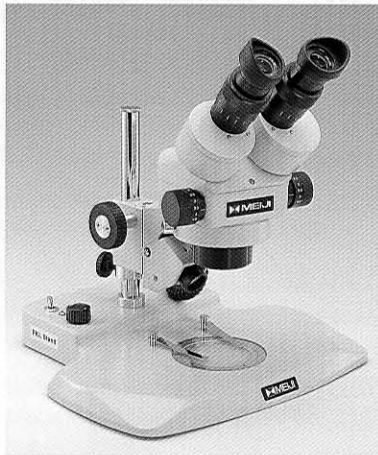

EMZ-5 / SWF10X / PKL

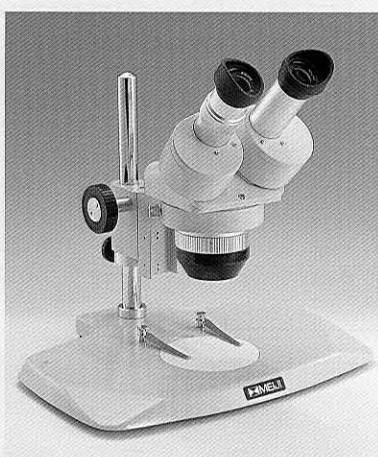
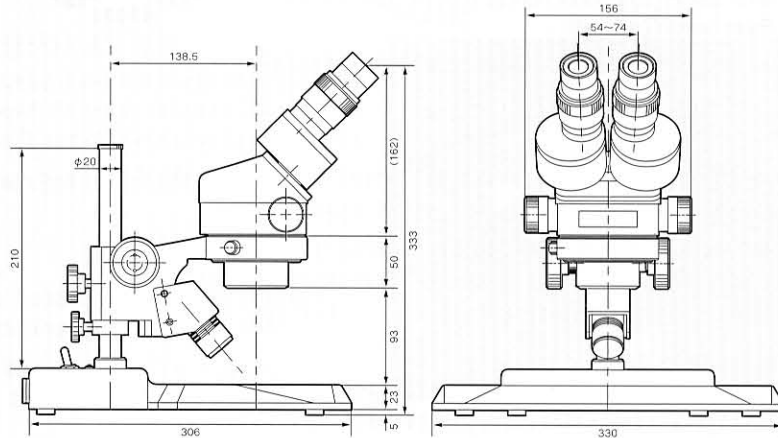

EMF-2 / SWF10X / PK

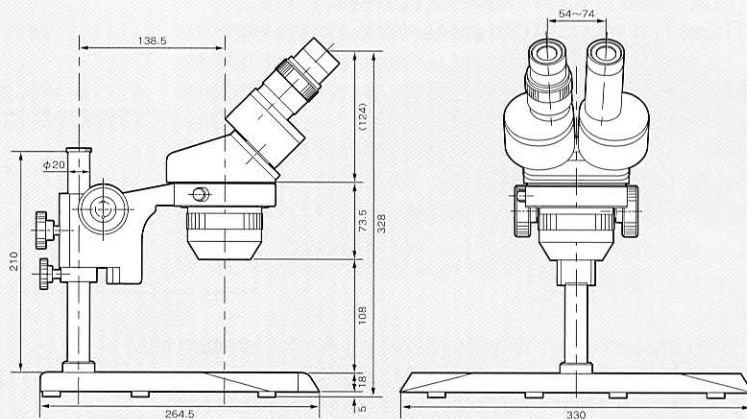

# EYEPIECES AND EYEPIECE ACCESSORIES

## EYEPIECES

A large selection of interchangeable super widefield eyepieces are available for all EM Series stereo microscopes.

- MA501** Super Widefield 5X Eyepiece, field No.26
- MA718** Super Widefield 7.5X Eyepiece with 25mm diameter reticle mount, field No.26
- MA502** Super Widefield 10X Eyepiece with 25mm diameter reticle mount, field No.23
- MA520** Super Widefield 12.5X Eyepiece with 25mm diameter reticle mount, field No.20
- MA503** Super Widefield 15X Eyepiece with 25mm diameter reticle mount, field No.15.4
- MA535** Super Widefield 15X High-eyepoint eyepiece with 25mm diameter reticle mount, field No.16.0
- MA504** Super Widefield 20X Eyepiece with 25mm diameter reticle mount, field No.11.5
- MA903** Super Widefield Focusing Eyepiece 20X with 25mm diameter reticle mount, field No.11.5
- MA521** Super Widefield 30X Eyepiece field No. 7.7
- MA519** Super Widefield 10X Focusing eyepiece (single) with 25mm diameter reticle mount, field No.21
- MA600** Eyeshields (paired)



Note: All eyepieces are paired unless otherwise indicated.

## EYEPIECE MICROMETERS

Eyepiece micrometers can be inserted into the 10X, 15X or 20X eyepieces for the purpose of specimen measurement. Linear scales, counting grids, and cross-line micrometers are just a few of the choices available to facilitate measurement of your specimens.

- MA523** Cross-line, 25mm diameter
- MA506** 10mm divided into 100 units, 25mm diameter
- MA509** 5mm divided into 100 units, 25mm diameter
- MA510** 10mm square divided into 100 parts, 25mm diameter (Each side of each individual square 1.0mm)
- MA524** 10mm square divided into 400 parts, 25mm diameter (Each side of each individual square 0.5mm)
- MA542** Cross-line with 0.01mm graduations, 25mm diameter

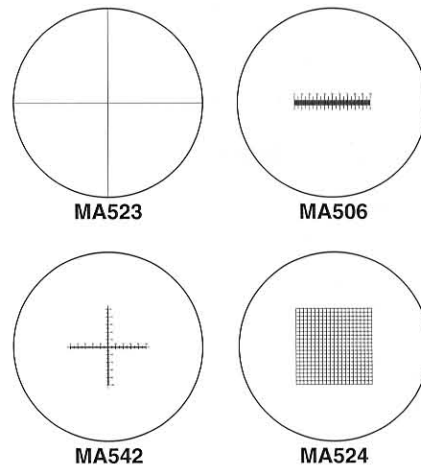

## STAGE MICROMETERS

Stage micrometers are used to calibrate eyepiece micrometers. Stage micrometers are available in both English and metric scales for reflected and transmitted light.

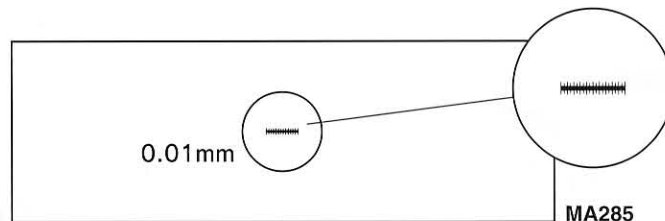

- MA285** 1mm divided into 100 units (0.01mm), for transmitted light
- MA286** 0.04" divided into 40 units (0.001"), for transmitted light
- MA287** 0.1mm by 0.1mm counting square for transmitted light
- MA292** 1mm divided into 100 parts(0.01mm), for reflected light



# AUXILIARY OBJECTIVE LENSES

A large selection of auxiliary objective lenses are available for EM Series stereo microscopes.

**AUXILIARY LENSES FOR: EMZ-1, EMZ-2, EMZ-2TR, EMZ-5, EMZ-5D, EMZ-5TR, EMZ-5TRD, EMZ-6, EMZ-9, EMZ-13 & EMZ-13TR**

- MA530** Auxiliary lens 0.3X, Working distance 251mm
- MA525** Auxiliary lens 0.44X, Working distance 171mm
- MA517** Auxiliary lens 0.5X, Working distance 148mm
- MA526** Auxiliary lens 0.75X, Working distance 97mm
- MA507** Auxiliary lens 1.5X, Working distance 49mm
- MA511** Auxiliary lens 2.0X, Working distance 33mm



**AUXILIARY LENSES FOR: EMZ-10 and Z-7100**

- MA545** Auxiliary lens 0.3X, Working distance 326mm
- MA558** Auxiliary lens 0.44X, Working distance 247mm
- MA546** Auxiliary lens 0.5X, Working distance 194mm
- MA547** Auxiliary lens 0.75X, Working distance 127mm
- MA548** Auxiliary lens 1.5X, Working distance 64mm
- MA549** Auxiliary lens 2.0X, Working distance 44mm



**AUXILIARY LENSES FOR: EMZ-8TR, EMZ-8TRD, EMZ-8TRU, EMZ-8UD**

- MA791** Auxiliary lens 0.28X, Working distance 300mm
- MA792** Auxiliary lens 0.35X, Working distance 280mm
- MA794** Auxiliary lens 0.5X, Working distance 174mm
- MA795** Auxiliary lens 1.5X, Working distance 57mm
- MA802** Auxiliary lens 2.0X, Working distance 36.6mm



**AUXILIARY LENSES FOR: EMT-2, EMTR-2, EMT-3, EMTR-3, EMT-4, EMTR-4**

- MA515** Adapter\*
- MA518** Auxiliary lens 0.5X, Working distance 108mm
- MA527** Auxiliary lens 0.75X, Working distance 72mm
- MA513** Auxiliary lens 1.5X, Working distance 35mm
- MA514** Auxiliary lens 2.0X, Working distance 22mm



\*NOTE: The MA515 adapter is required when using the MA518, MA527, MA513, or MA514 with the EMT-2 and EMTR-2

**AUXILIARY LENS FOR EMX-1, EMZ-12, EMZ-12D, EMZ-12TR & EMZ-12TRD**

- MA652** Auxiliary lens 0.7X Working distance 233mm
- MA796** Auxiliary lens 0.57X Working distance 300mm



# FOCUSING BLOCKS

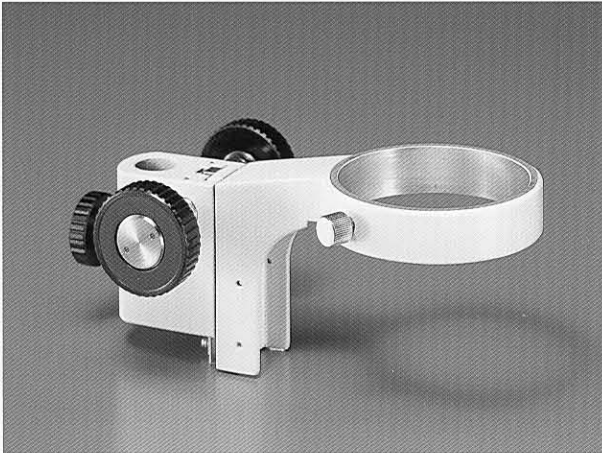

F

## F HOLDER

Focusing slide block designed to hold the stereo microscope body on machines or for special OEM applications. Rack and pinion mount allows smooth, precise focusing over 55mm of travel. Coarse focus mechanism incorporates a slip clutch and tension adjustment. Fits 20mm mounting post, 84.2mm diameter opening accepts 84mm stereo microscope body.

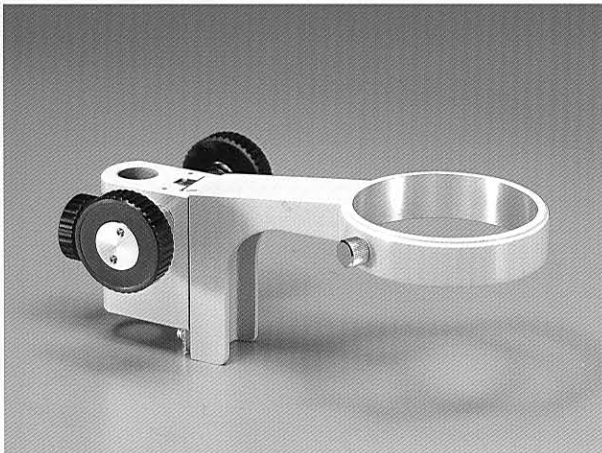

FK

## FK HOLDER

Focusing slide block designed to hold the stereo microscope body on machines or for special OEM applications. Rack and pinion mount allows smooth, precise focusing. Coarse focus mechanism incorporates a slip clutch and tension adjustment. Distance from center of holder to center of pillar is 27.8mm longer than other holders like F, FX, FS and FSC holders. Therefore, when using trinocular microscope bodies like EMZ-8TR or EMZ-13TR, it rotates smoothly without the part of straight tube protruded touching holder.



FX

## FX HOLDER

Special tilting focusing slide block with integral illuminator port designed to hold the stereo microscope body on machines or for special OEM applications. Rack and pinion mount allows smooth, precise focusing over 55mm of travel. Coarse focus mechanism incorporates a slip clutch and tension adjustment. 15.8mm (5 / 8") mounting pin, 84.2mm diameter opening accepts 84mm stereo microscope body.

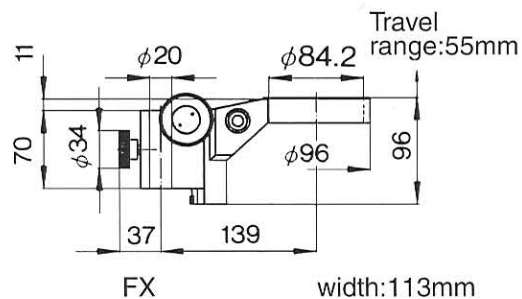



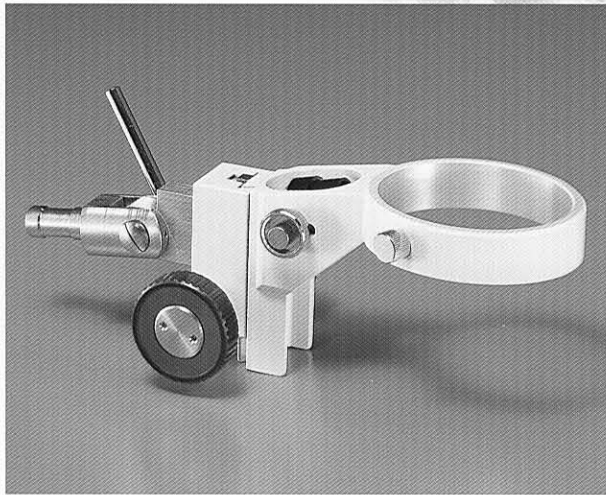

FS

### FS HOLDER

Special tilting focusing slide block with integral illuminator port designed to hold the stereo microscope body on machines or for special OEM applications. Rack and pinion mount allows smooth, precise focusing over 55mm of travel. Coarse focus mechanism incorporates a slip clutch and tension adjustment. 15.8mm (5 / 8") mounting pin, 84.2mm diameter opening accepts 84mm stereo microscope body.

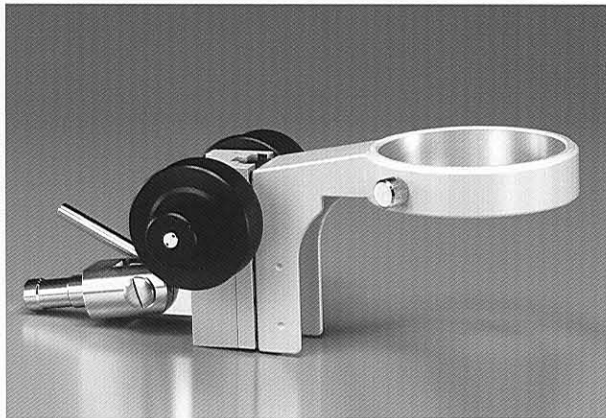
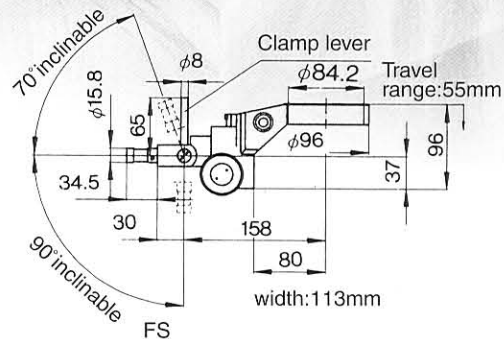

FSC

### FSC HOLDER

Special tilting focusing slide block designed to hold the stereo microscope body on machines or for special OEM applications. Coaxial coarse and fine focusing slide block designed for applications where precise fine focus adjustment is required. Rack and pinion mount allows smooth, precise focusing. Coarse focus mechanism incorporates a slip clutch and tension adjustment.

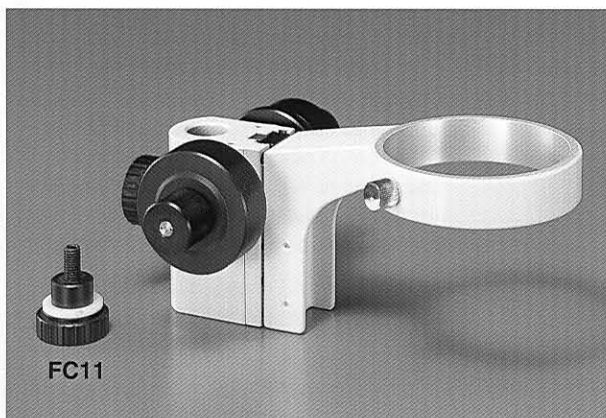

FC

### FC HOLDER

Coaxial coarse and fine focusing slide block designed for applications where precise fine focus adjustment is required. Rack and pinion mount allows smooth, precise focusing over 33 mm of travel. Coarse focus mechanism incorporates a slip clutch and tension adjustment. Fits 20mm mounting post, 84.2mm diameter opening accepts 84mm stereo microscope body. Note: 71mm mounting pins require FC11 extension

## Pole-type

# STANDS

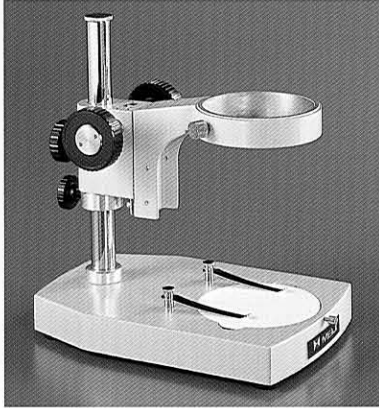

P

### P STAND

Pole-type stand with F holder focus block mounted on a plain base. Supplied with one 94.5mm diameter reversible black and white stage plate and two stage clips.

**Dimensions:** Length: 230mm / Width: 150mm  
Height: 248mm / Pillar Diameter: 20mm

### PK STAND

Pole-type stand with F holder focus block mounted on a plain flat base making much of stability and work-efficiency. PK stand accepts all MEIJI EM series binocular stereo microscope bodies.

F holder can be fixed at any position of pole. Supplied with one 94.5mm diameter reversible black and white stage plate and two stage clips.

**Dimensions:**  
Length: 265mm / Width: 330mm  
Height: 280mm / Pillar Diameter: 20mm

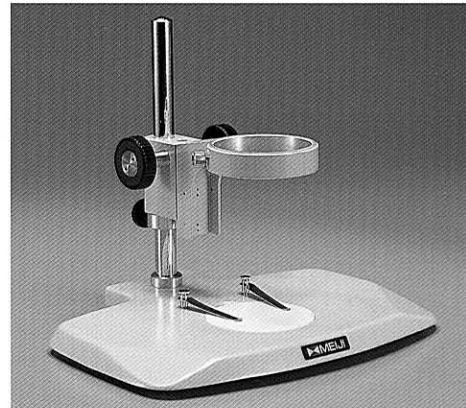

PK

### PL STAND

Pole type stand with FX holder focus block with incident light illuminator port mounted on a plain base. Supplied with one 94.5mm diameter reversible black and white stage plate and two stage clips.

**Dimensions:**  
Length: 230mm / Width: 150mm  
Height: 248mm / Pillar Diameter: 20mm

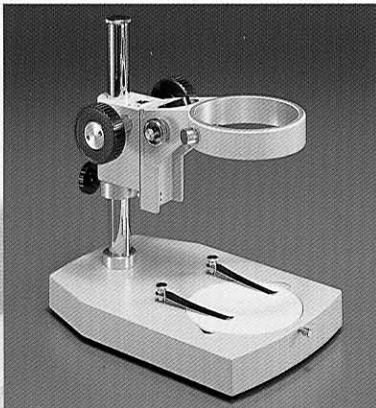

PL



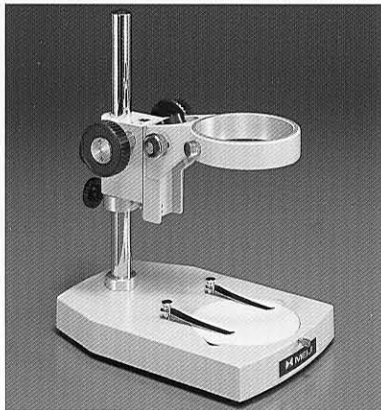

PX

### PX STAND

Extended working distance pole-type stand with FX holder focus block with incident illuminator port mounted on a plain base. Supplied with one 94.5mm diameter reversible black and white stage plate and two stage clips.

Designed for use with the EMX-1 extended working distance stereo body.

**Dimensions:**

Length: 230mm / Width: 150mm  
Height: 290mm / Pillar Diameter: 20mm

### PC STAND

Pole-type stand with FC coaxial coarse and fine focus block mounted on a plain base. 55mm Z axis travel. 138mm distance from optical center to center of mounting post. Supplied with one 94.5mm diameter reversible black and white stage plate and two stage clips.

**Dimensions:**

Length: 230mm / Width: 150mm  
Height: 248mm / Pillar Diameter: 20mm

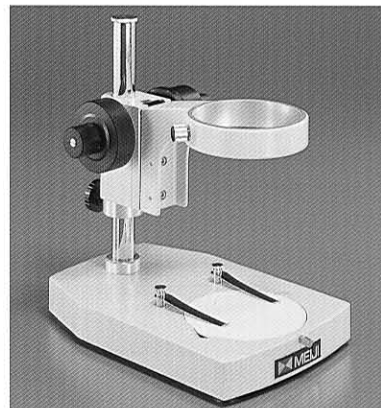

PC

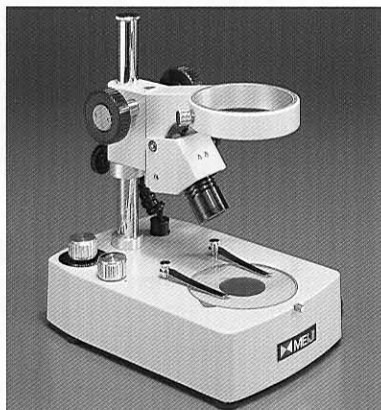

PBH

### PBH STAND

Pole-type stand with F holder focus block. Provides both transmitted and incident halogen illumination with variable intensity control. Illuminators may be operated independently or simultaneously.

Supplied with a 94.5mm diameter clear glass stage plate, reversible black and white stage plate and two stage clips.

6V 10W Halogen

**Dimensions:** Length: 240mm / Width: 160mm  
Height: 280mm / Pillar Diameter: 20mm  
**Bulbs:** Incident: MA570 / Trans: MA570

# Pole-type STANDS

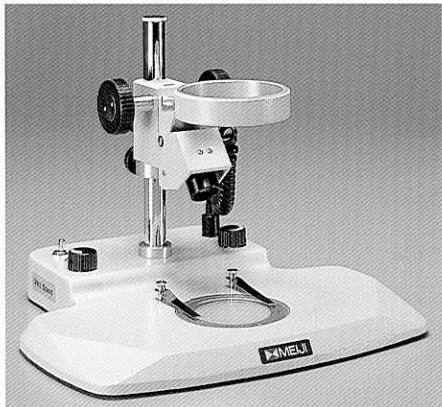

PKL

## PKL STAND

Pole-type stand with F holder focus block mounted on a flat base with integrated LED transmitted and incident illumination system. Automatic Voltage sensing power supply is incorporated.

PKL stand accepts all MEIJI EM Series binocular and trinocular bodies.

Dimensions: Length: 300mm / Width: 320mm  
Height: 255mm / Pillar Diameter: 20mm

## BX STAND

Pole-type stand with FX holder focus block with incident illuminator port. Transmitted light base includes a fully rotatable mirror for brightfield or "pseudo" darkfield work. Supplied with a 94.5mm diameter clear glass stage plate and two stage clips. Base and focus block accept optional versatile type illuminators. (MA264H or MA264)

Dimensions: Length: 240mm / Width: 160mm  
Height: 280mm / Pillar Diameter: 20mm  
Bulbs: Incident: MA570 / Trans: MA570

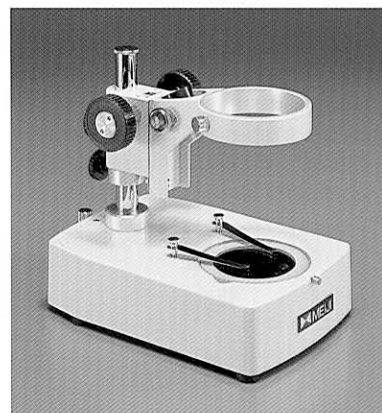

BX



# Rigid arm STANDS

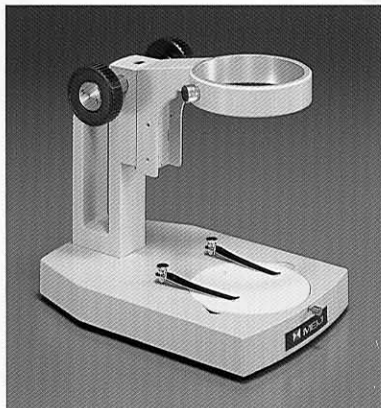

A

## A STAND

Rigid-arm type stand with integral focus block mounted on a plain base. Supplied with one 94.5mm diameter reversible black and white stage plate and two stage clips.

Note: The A stand is intended for use with fixed or turret type stereo bodies.

Dimensions: Length: 230mm / Width: 150mm  
Height: 203mm

## AZ STAND

Rigid-arm type stand with integral focus block mounted on a plain base. Supplied with one 94.5mm diameter reversible black and white stage plate and two stage clips.

Note: The AZ stand is intended for use with zoom stereo bodies.

Dimensions: Length: 230mm / Width: 150mm  
Height: 203mm

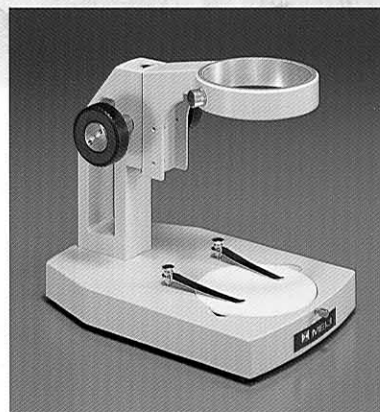

AZ

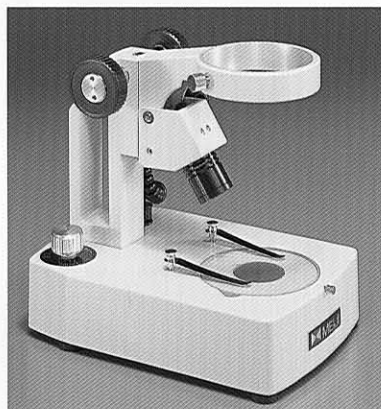

AB

## AB STAND

Rigid-arm type stand with integral focus block . Provides transmitted and incident tungsten illumination which may be operated independently or simultaneously. Supplied with a 94.5 mm diameter clear glass stage plate, reversible black and white stage plate and two stage clips. 6V 7.2W

Note: The AB stand is intended for use with fixed or turret type stereo bodies.

Dimensions: Length: 240mm / Width: 160mm  
Height: 233mm  
Bulbs: Incident: MA560 / Trans: MA561

## ABZ STAND

Rigid-arm type stand with integral focus block . Provides both transmitted and incident tungsten illumination which may be operated independently or simultaneously. Supplied with a 94.5 mm diameter clear glass stage plate, reversible black and white stage plate and two stage clips. 6V 7.2W

Note: The ABZ stand is intended for use with zoom stereo bodies.

Dimensions: Length: 240mm / Width: 160mm  
Height: 233mm  
Bulbs: Incident: MA570 / Trans: MA570

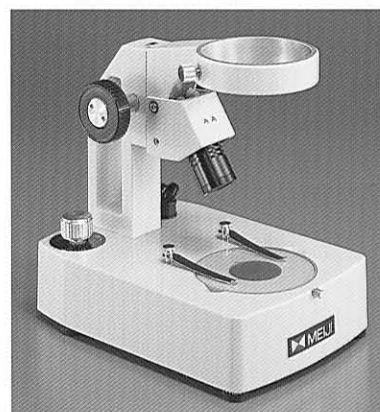

ABZ

## Rigid arm

# STANDS

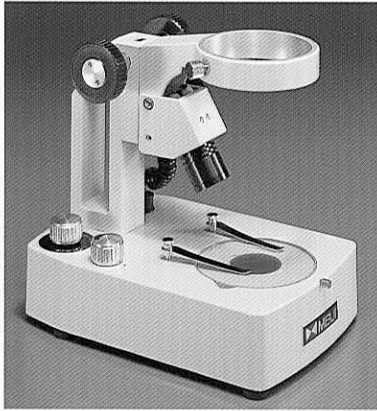

ABH

### ABH STAND

Rigid arm type stand with integral focus block . Provides transmitted and incident halogen illumination, independently or simultaneously with variable intensity control. Supplied with 94.5 mm diameter clear glass, black and white stage plates and two stage clips. 6V 10W Halogen

Note: The ABH stand is intended for use with fixed or turret bodies.

**Dimensions:** Length: 240mm / Width: 160mm  
Height: 233mm  
**Bulbs:** Incident: MA570 / Trans: MA570

### ABZH STAND

Rigid arm type stand with integral focus block . Provides transmitted and incident halogen illumination, independently or simultaneously with variable intensity control. Supplied with 94.5 mm diameter clear glass, black and white stage plates and two stage clips. 6V 10W Halogen

Note: The ABZH stand is intended for use with zoom stereo bodies

**Dimensions:** Length: 240mm / Width: 160mm  
Height: 233mm  
**Bulbs:** Incident: MA570 / Trans: MA570

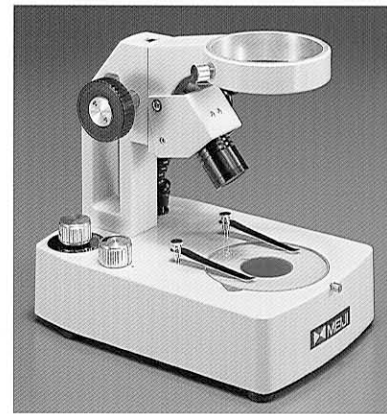

ABZH

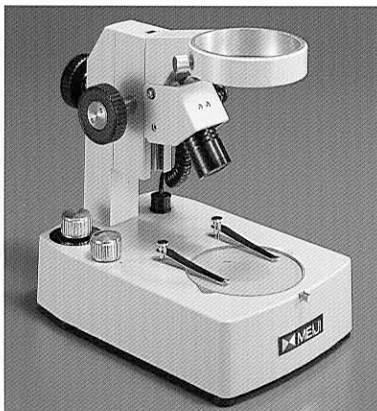

ABE

### ABE STAND

Rigid arm type stand with integral focus block and extendable working distance . Provides transmitted and incident halogen illumination, independently or simultaneously with variable intensity control. Supplied with 94.5 mm diameter clear glass, black and white stage plates and two stage clips. 6V 10W Halogen

**Dimensions:** Length: 240mm / Width: 160mm  
Height: 240mm-300mm  
**Bulbs:** Incident: MA570 / Trans: MA570

### B STAND

Rigid arm type stand with integral focus block. A dual-reflection lens system provides incident, transmitted, or simultaneous illumination. A fully rotatable mirror in the base provides transmitted light brightfield or "pseudo" darkfield illumination. Supplied with 94.5 mm diameter clear glass, black and white stage plates and two stage clips. 115V 20W

**Dimensions:** Length: 245mm / Width: 160mm  
Height: 233mm  
**Bulbs:** MA261/SL10

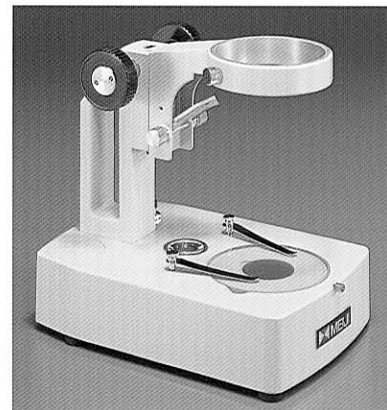

B



With extended work surface

# STANDS

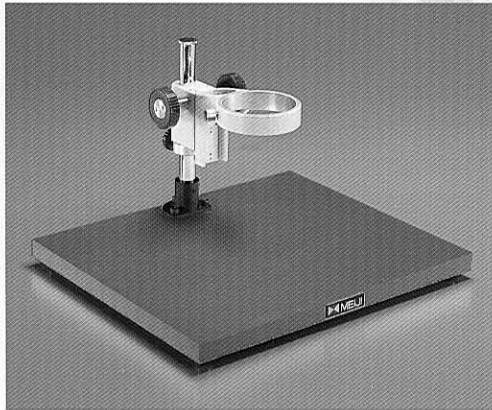

KBL

## KBL STAND

Pole type stand with FX holder focus block with incident illuminator port mounted on a 380mm x 330mm x 20mm flat laminate base. Optional 100mm (4") pillar extension (MA551) can provide additional clearance or working distance.

**Dimensions:**

Length: 330mm / Width: 380mm / Height: 245mm

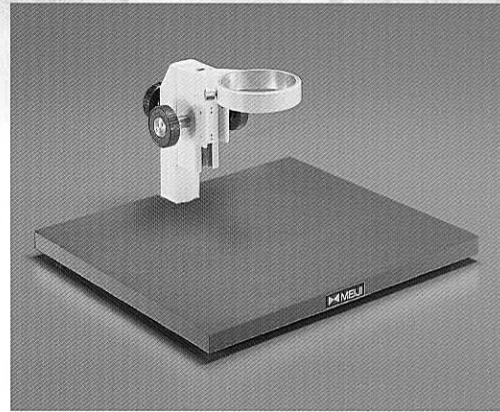

KBE

## KBE STAND

Rigid arm type stand with integral focus block mounted on a 380mm x 330mm x 20mm flat laminate base. The rigid arm can be extended to accommodate large specimens and a wide variety of auxiliary objective lenses.

**Dimensions:**

Length: 330mm / Width: 380mm / Height: Variable

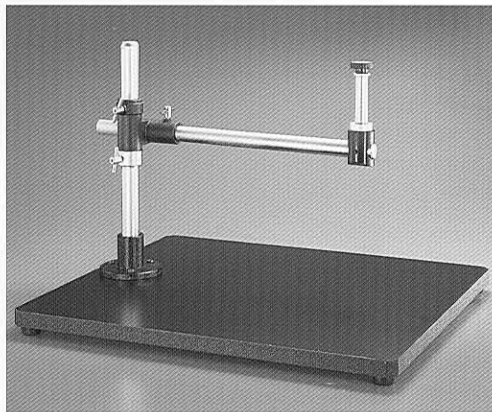

SBU

## SBU STAND

Special universal-type stand with pillar, crossarm and mounting post mounted directly over a large flat laminate work surface. Provides flexible horizontal and vertical movement for large specimens. 20mm diameter short mounting post accepts optional F, FX or FC holders.

Base: 580mm x 500mm x 38mm.

**Dimensions:**

Horizontal pole / Length: 480mm / Diameter: 25mm  
Vertical pole / Length: 365mm / Diameter: 29mm

## UL STAND

Special universal-type stand with pillar, crossarm, mounting post, and rotatable tray to hold optional fiber optic light source. Provides flexible horizontal and vertical movement for large specimens. 20mm diameter short mounting post accepts optional F, FX or FC holders.

Base: 580mm x 500mm x 38mm.

**Dimensions:**

Horizontal pole / Length: 480mm / Diameter: 25mm  
Vertical pole / Length: 365mm / Diameter: 29mm

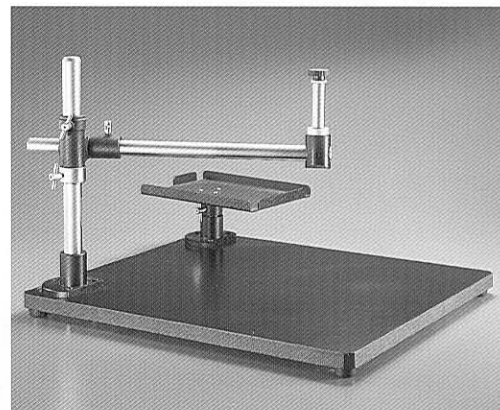

UL

# Universal boom STANDS

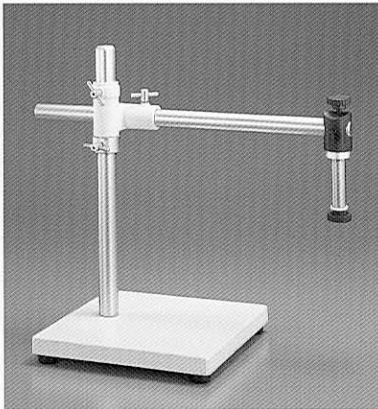

S-4100

## S-4100 STAND

Industrial-type boom stand with 20mm mounting post for F, FX or FC holders. Provides complete flexibility for horizontal and vertical adjustment. Sturdy solid metal 265mm x 265mm x 25mm base provides excellent stability.

Note: F, FX and FC holders must be ordered separately.

### Dimensions:

Horizontal pole / Length: 530mm / Diameter: 25mm  
Vertical pole / Length: 400mm / Diameter: 29mm

## S-4200 STAND

Extended working distance industrial-type boom stand with 20mm mounting post for F, FX or FC holders. Provides complete flexibility for horizontal and vertical adjustment. Sturdy, solid metal 265mm x 265mm x 25mm base provides excellent stability.

Note: F, FX and FC holders must be ordered separately.

### Dimensions:

Horizontal pole / Length: 530mm / Diameter: 25mm  
Vertical pole / Length: 610mm / Diameter: 29mm

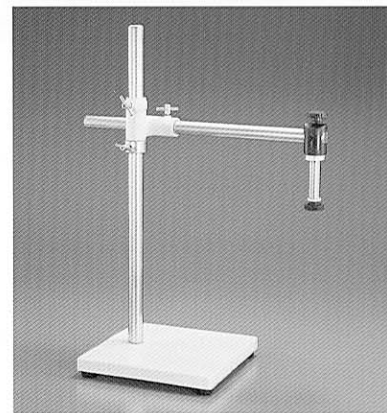

S-4200

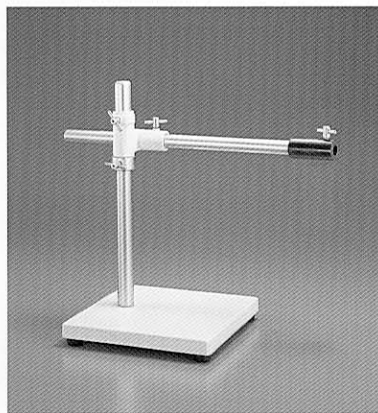

S-4300

## S-4300 STAND

Industrial-type boom stand with adapter(MA552)for FS holder. Provides complete flexibility for horizontal, vertical and angular adjustment. FS holder can be inclined 180° and rotated 360°, 16mm diameter mounting pin. Sturdy, solid metal 265mm x 265mm x 25mm base.

Note: FS holder must be ordered separately.

### Dimensions:

Horizontal pole / Length: 530mm / Diameter: 25mm  
Vertical pole / Length: 400mm / Diameter: 29mm

## S-4400 STAND

Extended working distance industrial-type boom stand with adapter (MA552) for FS holder. Provides complete flexibility for horizontal, vertical and angular adjustment. FS holder can be inclined 180° and rotated 360°, 16mm diameter mounting pin. Sturdy, solid metal 265mm x 265mm x 25mm base.

Note: FS holder must be ordered separately.

### Dimensions:

Horizontal pole / Length: 530mm / Diameter: 25mm  
Vertical pole / Length: 610mm / Diameter: 29mm

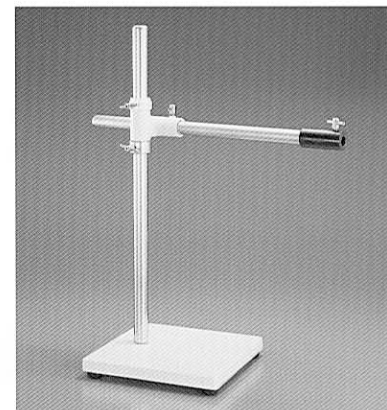

S-4400



# Articulated Arm, Clamp Boom, Extended Work Surface STANDS

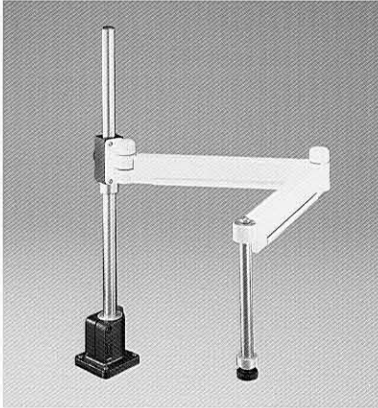

FA-1

## FA-1 ARTICULATED ARM STAND

Articulated arm stand for bench top attachment. Supplied with mounting flange, two piece folding arm, vertical mounting pillar and 20 mm diameter mounting pin for focus block. Maximum distance from rod to center of optical axis is 1000mm.

Note: F, FX or FC holder must be ordered separately.

### Dimensions:

Length: 1100mm / Width: 100mm / Height: 560mm  
Pillar Diameter: 20mm

## FA-2 ARTICULATED ARM STAND

Articulated arm stand designed for mounting to a vertical surface. Supplied with mounting flange, two piece folding arm, and 20 mm diameter mounting pin for focus block. Maximum distance from rod to center of optical axis is 1080mm.

Note: F, FX or FC holder must be ordered separately.

### Dimensions:

Base / Length: 1100mm / Width: 100mm  
Pillar Diameter: 20mm

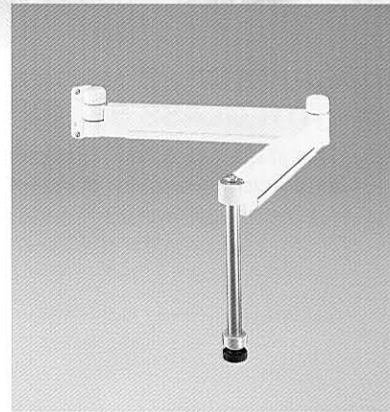

FA-2

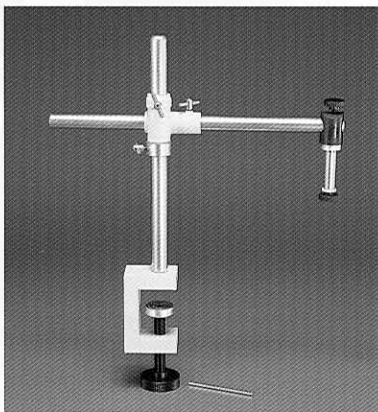

S-4500

## S-4500 STAND

Industrial-type boom stand with 20mm mounting post for F, FX and FC holders. Provides complete flexibility for horizontal and vertical adjustment. Sturdy solid metal clamp provides excellent stability.

Note: F, FX and FC holders must be ordered separately.

### Dimensions:

Horizontal pole / Length: 530mm / Diameter: 25mm  
Vertical pole / Length: 400mm / Diameter: 29mm

## MU STAND

Special universal-stand with pillar, crossarm and mounting post mounted over a laminate work surface. Provides flexible horizontal and vertical movement for mid sized specimens. 20mm diameter short mounting post accepts F, FX or FC holders. Base: 350mm x 410mm x 30mm

Note: F, FX or FC holder must be ordered separately.

### Dimensions:

Horizontal pole / Length: 330mm / Diameter: 25mm  
Vertical pole / Length: 365mm / Diameter: 29mm

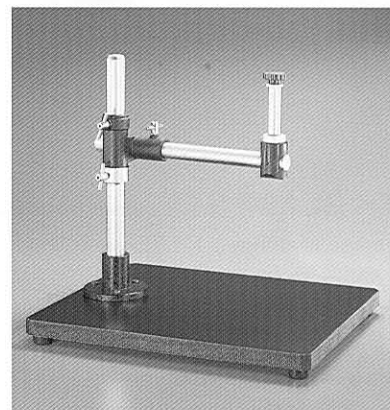

MU

# STAGES

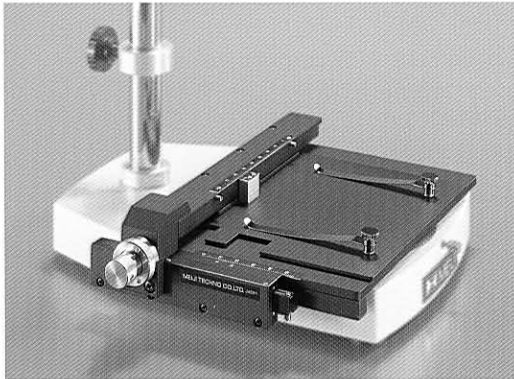

MA564

## GRADUATED MECHANICAL STAGE

This stage has 0.1mm graduations and coaxial controls for precise movement of mounted specimens. Features a 116mm x 137mm work surface with stage clips, 50mm x 75mm X-Y travel.

**Catalog Number: MA564**

## GRADUATED MECHANICAL STAGE WITH GLASS STAGE PLATE

This stage has 0.1mm graduations and coaxial controls for precise movement of mounted specimens. Features a 116mm x 137mm work surface with stage clips and 74mm x 96mm clear glass plate for use with transmitted light stands, 50mm x 75mm X-Y travel.

**Catalog Number: MA564/05**

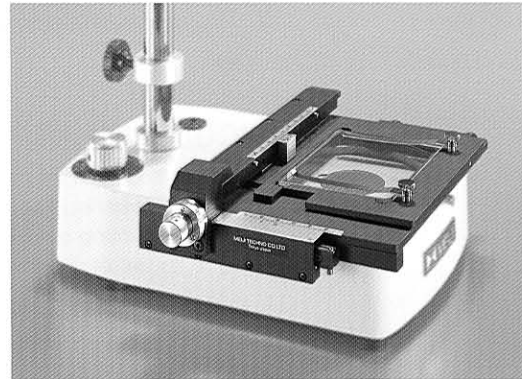

MA564/05

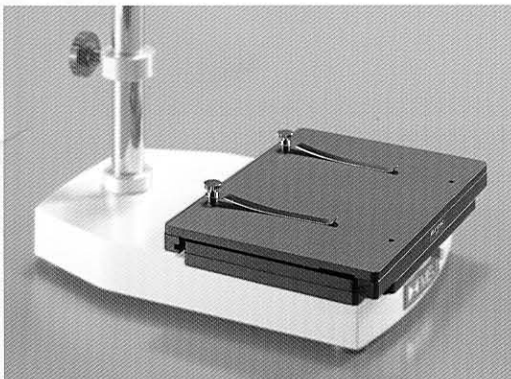

MA565

## UNGRADUATED MECHANICAL STAGE

This stage features a 125mm x 170mm work surface with stage clips. Roller bearing mount allows smooth, easy, fingertip control over 100mm x 100mm, X-Y travel.

**Catalog Number: MA565**

## UNGRADUATED MECHANICAL STAGE WITH GLASS STAGE PLATE

This stage features a 125mm x 170mm work surface with stage clips and a 94.5mm diameter clear glass stage plate for use with transmitted light stands. Roller bearing mount allows smooth, easy, fingertip control over 100mm x 100mm, X-Y travel.

**Catalog Number: MA565/05**

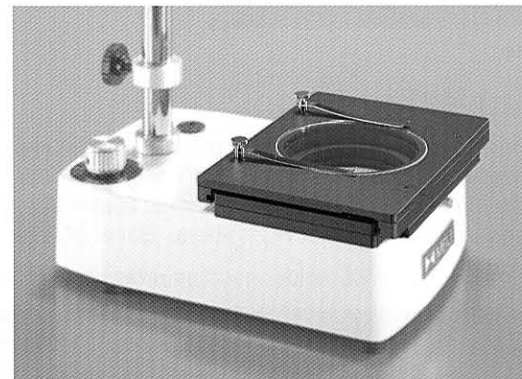

MA565/05



# STAGES AND ACCESSORIES

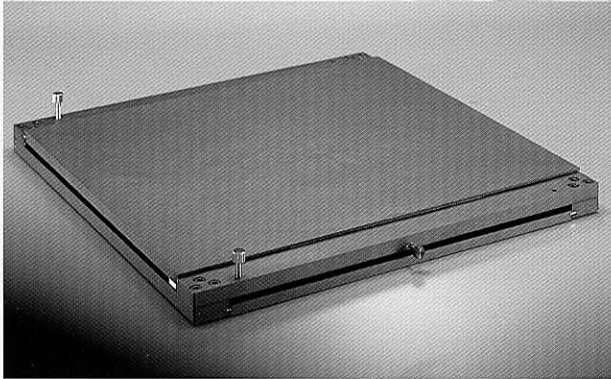

**MA574**

## MEDIUM SLIDING STAGE

Medium 292mm x 235mm (11.5"x 9.24") roller bearing stage with 203mm x 101mm (8"x 4") X-Y travel. Black anodized with X-Y lock down screws.

**Catalog Number: MA575**

## LARGE SLIDING STAGE

Large 395mm x 395mm (15.5"x 15.5") roller bearing stage with 350mm x 270mm (13.78"x 10.63") X-Y travel. Black anodized with X-Y lock down screws.

**Catalog Number: MA574**

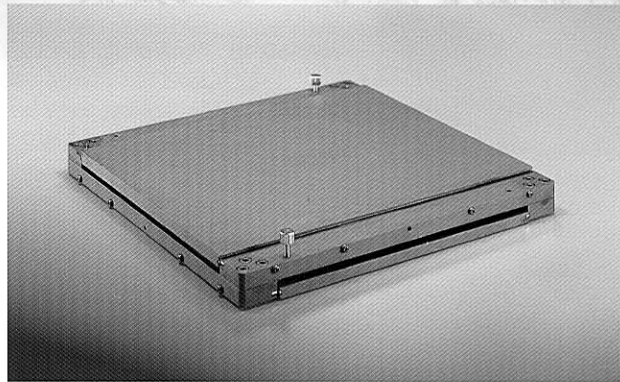

**MA575**



**MA571**

## OBLIQUE VIEWING ATTACHMENT

Designed specifically for the inspection of solder connections, rework and repair of electronic circuits and for mounting small electronic components. One-touch sliding movement allows the user to quickly change from vertical to oblique viewing. Rotatable 360°. Vertical working distance 110mm. Oblique working distance 130mm.

Note: For use with Zoom Stereo EMZ-5, EMZ-5TR, EMZ-2 and EMZ-2TR bodies only.

**Catalog Number: MA571**

## OBLIQUE VIEWING ATTACHMENT

Designed especially for the inspection of solder connections, rework and repair of electronic circuits and for mounting small electronic components. One-touch sliding movement allows the user to quickly change from vertical to oblique viewing. Rotatable 360°. Vertical working distance 110m. Oblique working distance 130mm.

Note: For use with Zoom Stereo EMZ-8TR (Includes built-in 0.35X lens for oblique observation and 0.58X for vertical observation.)

**Catalog Number: MA797**

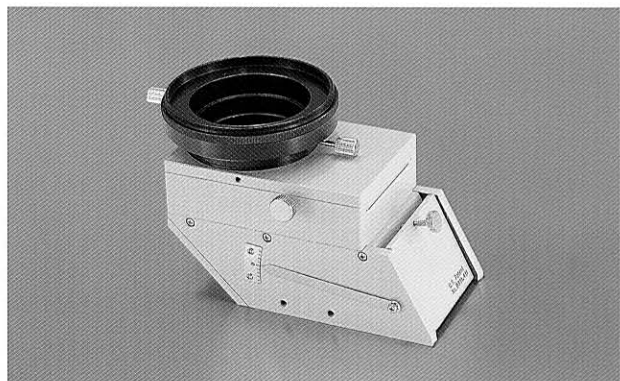

**MA797**

# ACCESSORIES

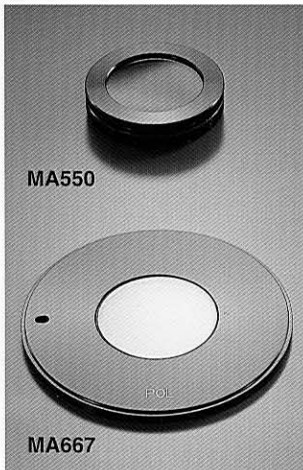

## Simple Polarizing Attachments

When used in conjunction with the MA667 polarizing plate the MA550 rotatable polarizing filter functions as an analyzer and is useful for viewing or detecting birefringent materials. (eg. mineral specimens, organic and inorganic crystal specimens, bone specimens, strained glass, etc.)

## EM Series Polarizing Filters In Rotatable Mounts

- MA550** Polarizing filter for EMZ Zoom stereo microscopes
- MA550/05** Polarizing filter for EMT-1, EMTR-1, EMT-2, EMTR-2, EMF-1, and EMF-2 stereo bodies
- MA550/10** Polarizing filter for EMT-3, EMTR-3, EMT-4, and EMTR-4 stereo bodies
- MA667** Polarizing plate for use with PB, PBH, PBM, AB, ABH, ABZH, ABE Transmitted Light Stand

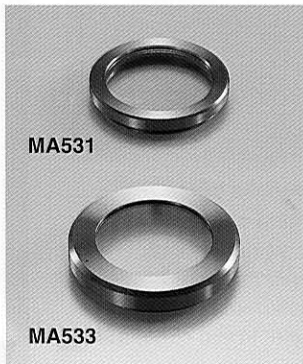

## Protective Glass Attachments

Used to protect EM Series microscope objectives from harmful residue, vapors, solvents, debris etc.

- MA531** Protective glass for EMZ Zoom stereo microscopes
- MA532** Protective glass for EMZ Zoom stereo body with MA305 fluorescent illuminator
- MA533** Protective glass for EMT-1, EMTR-1, EMT-2, EMTR-2, EMF-1 and EMF-2
- MA537** Protective glass for EMT-3, EMTR-3, EMT-4 and EMTR-4



## Adapters For FL152 Annular Fiber Optic Illuminators

- MA553** Adapter to fit annular fiber optic ring illuminator on EMT-1, EMTR-1, EMT-2, EMTR-2, EMF-1, and EMF-2 (Fits 60mm I.D. ring illuminators)
- MA553/05** Adapter to fit annular fiber optic ring illuminator on EMT-3, EMTR-3, EMT-4 and EMTR-4



## Adapters For Fluorescent Illuminators

- MA302** Adapter to mount MA305 fluorescent illuminator on EMZ Zoom stereo microscope
- MA303** Adapter to mount MA305 fluorescent illuminator on MA507 and MA511 auxiliary lenses
- MA304** Adapter to mount MA305 fluorescent illuminator on EMT-1, EMTR-1, EMT-2, EMTR-2, EMF-1 and EMF-2
- MA307** Adapter to mount MA305 fluorescent illuminator on EMT-3, EMTR-3, EMT-4 and EMTR-4



# CONFIGURATION SAMPLES



**SMD INSPECTION SYSTEM :** EMZ-8TR Zoom stereo microscope, F Focus block, MA797 oblique viewing attachment, MA503 Super widefield 15X eyepieces, UL universal stand, MA574 sliding stage, FL151 dual arm 150W fiber optic illumination system, MA151/5N video "C" mount, CK3900 video camera and video monitor.

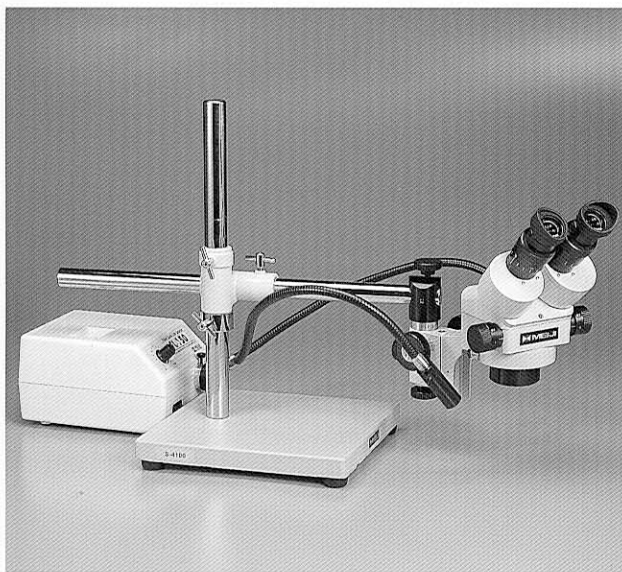

EMZ-5 / SWF10X / S-4100 / FL151

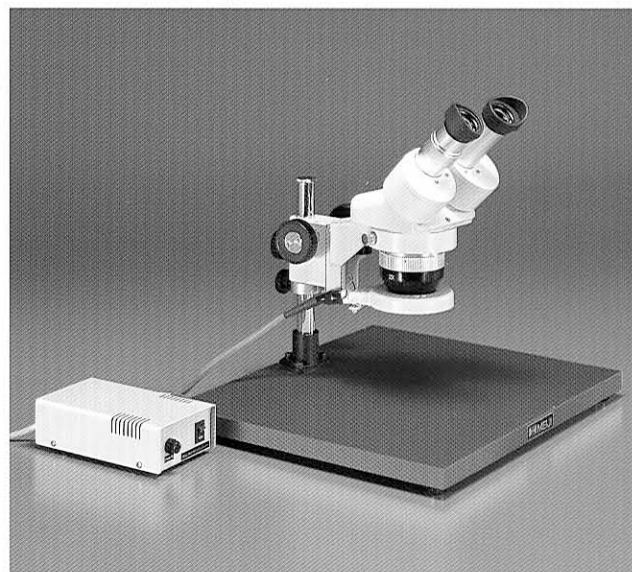

EMT-1 / SWF10X / KBL / MA305

# ILLUMINATION

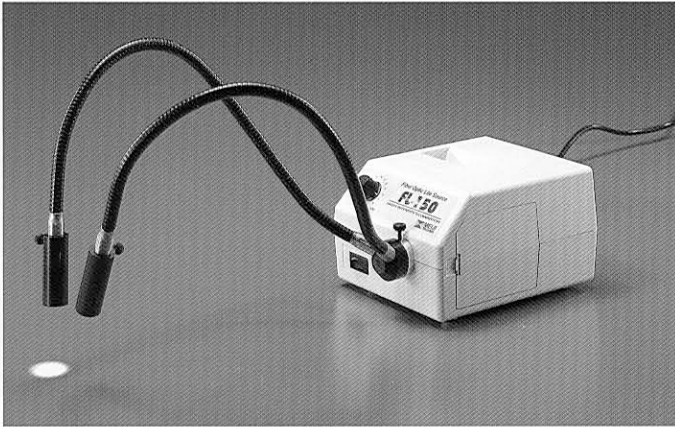

FL151

## DUAL-ARM FIBER OPTIC ILLUMINATOR

150 Watt quartz halogen light source with self-supporting dual arm light guides, connecting adapter and focusing lenses. Rheostat controlled intensity. Color temperature 3200°K. UL listed and CSA approved.

**Catalog Number: FL151/100 (115V)**  
**FL151/200 (220/240V)**

## ANNULAR FIBER OPTIC ILLUMINATOR

150 Watt quartz halogen light source with 60mm I.D. annular light guide and connecting adapter. Rheostat controlled intensity. Color temperature 3200°K. UL listed and CSA approved.

**Catalog Number: FL152 / 100 (115V)**  
**FL152 / 200 (220/240V)**



FL152

## ACCESSORIES FOR FL150 SERIES

- FL150/100** Light source for 100/120V, 50/60Hz operation, halogen lamp, 21V 150W, with light-intensity regulation, maximum color temperature 3200°K, with AC fan
- FL150/200** Light source for 220/240V, 50/60Hz operation, halogen lamp, 21V 150W, with light-intensity regulation, maximum color temperature 3200°K, with AC fan
- FL150/05** Dual arm light guide, self supporting, each arm with 5mm (0.20") dia. active fiber optic bundle
- FL150/10** Annular light guide, 60mm (2.36") dia. ring aperture, 9.5mm (0.373") dia. fiber bundle
- FL150/12** Flexible 914.4mm (36") single arm fiber light guide with special end tip to fit EMZ-12, EMZ-12TR, EMZ-12TRD
- FL150/15** Dual arm light guide, each arm with 4.75mm (0.187") diam. fiber optic bundle
- FL150/50** Lens, 28mm F.L. (for use with FL150/05 and FL150/75)
- FL150/65** Annular light guide for use with MS-3
- FL150/70** Spare bulb, 21V 150W (EKE)
- FL150/75** Single arm light guide (20" self-supporting) 0.25" (6.35mm) diameter fiber optic bundle. Require one FL150/50 lens
- FL150/80** Single arm light guide (flexible), 4.75mm (0.187") dia. fiber optic bundle
- FL150/85** Polarizer cap (fits FL150/50)
- FL150/95** Single arm light guide (36" flexible) 0.187" (4.75mm) diameter fiber optic bundle. For use with VM Series video microscopes.
- FL150/FUSE-A** Fuse 3A 5 x 20mm, slow blow (115V)
- FL150/FUSE-B** Fuse 2A 5 x 20mm, slow blow (230V)



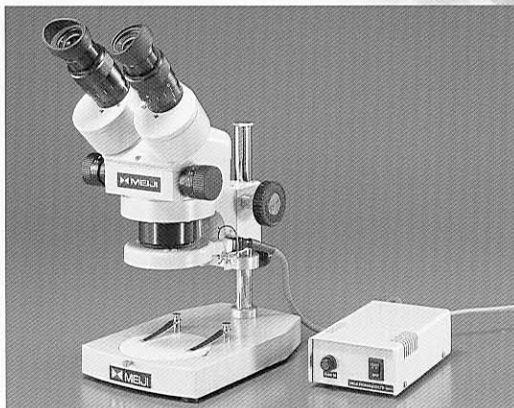

**MA305**

### RING FLUORESCENT ILLUMINATOR

Provides 360° of cool white shadow-free illumination.  
 Lightweight, compact, rugged.  
 Light Output: 8W  
 Color Temperature: 6500K  
 Lamp Life: 1500 Hours

**Catalog Number: MA305 / 100 (115V)**  
**MA305 / 200 (220 / 240V)**  
**Replacement Bulb: MA305 / 05**

### VERSATILE HALOGEN ILLUMINATOR

Versatile halogen illuminator with prefocused three lens collecting system, detachable articulating arm, with swivel joint. Provides sharply defined spot without color fringes. Rheostat control. Acid and reagent resistant. 6V 20W

**Catalog Number: MA264H / 100 (115V) MA264H / 200 (220 / 240V)**  
**Replacement Bulb: MA260 / 05**

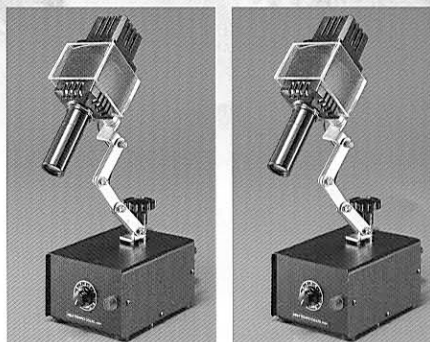

**MA264H**

**MA264**

### VERSATILE TUNGSTEN ILLUMINATOR

Versatile tungsten illuminator with prefocused three lens collecting system, detachable articulating arm, with swivel joint. Provides sharply defined spot without color fringes. Rheostat control. Acid and reagent resistant. 6V 18W

**Catalog Number: MA264 / 100 (115V) MA264 / 200 (220 / 240V)**  
**Replacement Bulb: MA264 / 05**

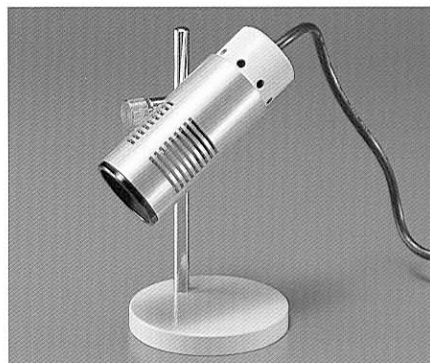

**MA263**

### FREE STANDING ILLUMINATOR

High intensity, long life daylight, miniature flood-light bulb. Enclosed in a vented, adjustable lamphouse. Heat absorbing filter is built in. 30W

**Catalog Number: MA263 / 100 (115V) MA263 / 200 (220 / 240V)**  
**Replacement Bulb: MA263 / 05 (115V) MA263 / 10 (220 / 240V)**

### SPARE BULBS

CAT. No	DESCRIPTION	USE FOR
MA260/05	Halogen lamp, 6V 20W	MA260, MA264, MA264EX illuminators
MA263/05	Miniature flood bulb 115V 30W	MA263 Free stand illuminators
MA263/10	Miniature flood bulb 220/ 240V 30W	MA263 Free stand illuminators
MA264/05	Bulb 6.5V 2.75A	MA264 Versatile illuminators
MA305/05	Ring fluorescent tube, Daylight/DL.8W, 6500°K	MA305/100 and MA305/200 Ring fluorescent illuminators
MA305/10	Ring fluorescent tube, Warm White/DL.8W, 3500°K	MA305/100 and MA305/200 Ring fluorescent illuminators
MA560	Bulb 6V 1.2A	Incident light of AB, ABZ, PB stands
MA561	Bulb 6V 1.2A	Transmitted light of AB, ABZ, PB stands
MA570	Halogen lamp, 6V 10W	Incident and Transmitted light of AB, ABZH, PBH stands
MA590	Bulb 115V 15W frosted	PBM stand
FL150/70	Halogen lamp, 21V 150W	FL150 light source for fiber light guide

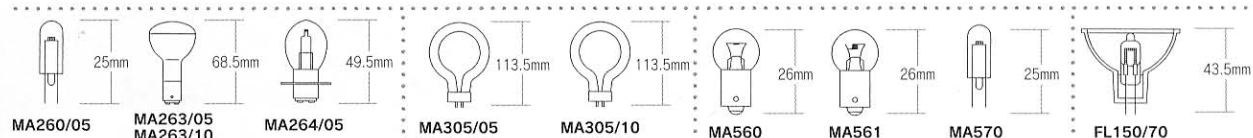

# CAMERAS FOR VIDEO MICROSCOPY

The Meiji Techno CCD color video cameras, high-resolution, single chip cameras offer a large array of features that make them ideal for industrial, medical, educational, or research applications. Durable, compact and lightweight these cameras are a perfect match for use with the EM Series Stereo Microscopes.

## COLOR VIDEO CAMERAS

### Model: CK3900N or CK3900P

Description: CCD color video camera

CCD: 1 / 2" Interline-Transfer type

Elements: 768(H) x 494(V) NTSC

752(H) x 582(V) PAL

TV System: NTSC or PAL

Lens Mount: "CS" mount

White Balance: 3200°K / 4600°K / 5600°K / ATW

AGC: 0dB ~ 18dB

Shutter: Electronic, 1 / 60 (1/50) ~ 1 / 10,000 second

Power: 12VDC + 10%

Horizontal Resolution: 450 TV lines

S/N: 50 dB

Video Output: VBS ( $\gamma=0.45$ )

Minimum Sensitivity : 0.3 lux on CCD surface  
(AGC on)

External Sync: HD/VD, Composite sync

Power Consumption 4.5W

Storage Temperature: -25°C ~ 40°C

Operating Temperature: 0°C ~ 40°C

Dimensions: 51mm(W) x 43mm(H) x 128mm(L)

Net Weight: 380g

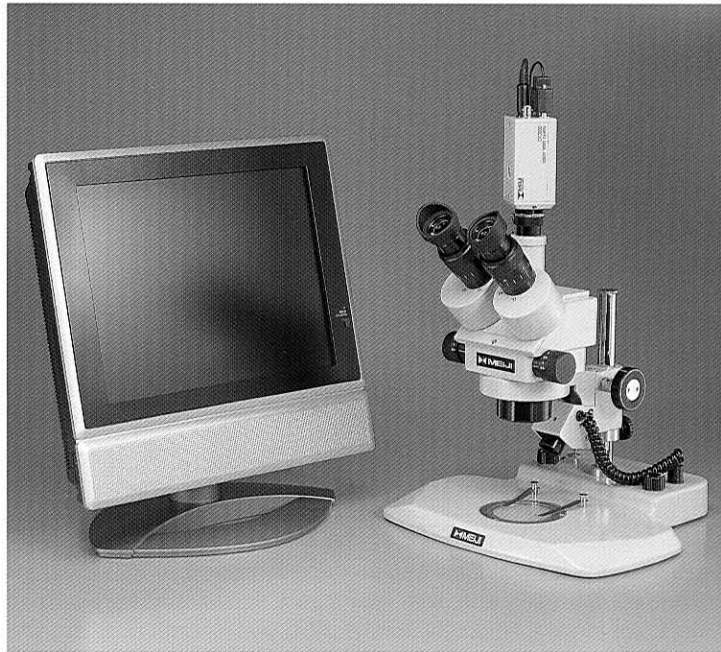

**CK3900** Color Video camera mounted on **EMZ-5TR / PKL** stand and connected to color video monitor through **MA151/5N** video "C" mount.

## COLOR DIGITAL CAMERA

### Model: DK3000

3.0 megapixel, color digital video microscopy camera with high speed USB 2.0 interface, 1/2 format 6.5mm x 4.9mm image sensor with 2048 x 1536 resolution.

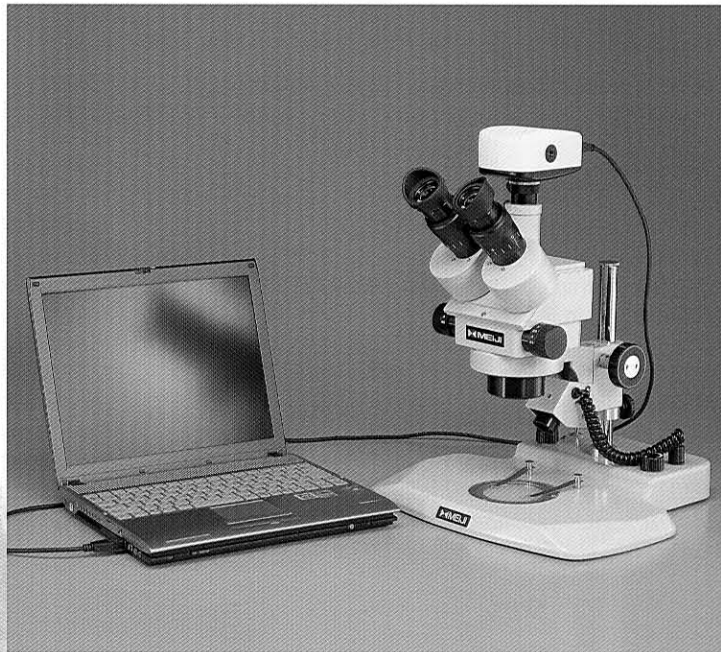

**DK3000** Color digital camera on **EMZ-5TR / PKL** stand and connected to PC through **MA151/5N** video "C" mount.



# VIDEO "C" MOUNTS

A video "C" mount is used to connect the CCD camera to the trinocular tube of the EM Series stereo microscope. Since their introduction, CCD video imagers have continually decreased in size. CCD formats of 2/3", 1/2", 1/3", and 1/4" are common. The smaller the CCD imager the greater the video magnification. Choosing the correct "C" mount for your application allows you to control the magnification on the video monitor. Meiji Techno offers the following "C" mounts for the EM Series microscopes:



**MA151 / 5N**  
Adapter  
without lens

**MA151 / 35 / 04**  
Adapter with  
0.45 X lens

**MA151 / 35 / 20**  
Adapter with  
0.7 X lens

**MA151 / 35 / 15**  
Adapter with  
1.0 X lens

**MA151 / 35 / 25**  
Adapter with  
2.5 X lens

**MA151 / 8TR**  
0.6 X lens  
for **EMZ-8TR**  
**EMZ-12TR**  
**EMZ-13TR**

Note: MA151 adapters are designed to be used in conjunction with the existing trinocular tube with the exception of the MA151 / 5N, which replaces the trinocular tube.

The total magnification displayed on a video monitor is determined by the following formula:

**Total magnification = Objective magnification x "C" mount magnification x Video magnification**

To determine the objective magnification multiply the magnification number found on the zoom control or turret setting times the magnification power of any auxiliary lens being used. The video magnification is determined by dividing the diagonal (mm) measurement of the video monitor by the diagonal (mm) measurement of the CCD video camera chip. Tables of common CCD chip dimensions and video monitor magnifications are listed below.

**Common CCD Dimensions**

Chip Format	Height	Width	Diagonal
1 / 3"	3.6mm	4.8mm	6mm
1 / 2"	4.8mm	6.4mm	8mm
2 / 3"	6.6mm	8.8mm	11mm

**Common Video Magnifications**

	9"	12"	13"	19"	20"	27"
1 / 3"	38.1X	50.8X	55.0X	80.4X	84.7X	114.3X
1 / 2"	28.6X	38.1X	41.3X	60.3X	63.5X	85.7X
2 / 3"	20.8X	27.7X	30.0X	43.9X	46.2X	62.3X

Note: Top row denotes monitor screen size measured diagonally  
To convert from inches to mm multiply by 25.4

The actual size of a specimen can be determined by dividing the length of the specimen measured on the monitor by the total magnification of the monitor.

# PHOTOMICROSCOPY ACCESSORIES

Three parts are required for mounting a 35mm or Digital SLR camera body to the EM Series trinocular microscope bodies:

1. The appropriate T-2 adapter ring for your SLR camera body:

<b>T2-1</b> Canon	<b>T2-2</b> Minolta
<b>T2-3</b> Pentax K (bayonet)	<b>T2-4</b> Pentax S (threaded)
<b>T2-5</b> Nikon	<b>T2-6</b> Olympus
<b>T2-7</b> Contax, Yashica	<b>T2-8</b> Konica
<b>T2-9</b> Cannon EOS	<b>T2-10</b> Minolta Alpha / Maxim 2000

The T2 adapter rings connect your camera body to one of the MA150 camera attachments.

2. A photo eyepiece, available in the following magnifications:

<b>MA512</b> 2.5X magnification
<b>MA500</b> 3.3X magnification (with reticle mount)
<b>MA508</b> 5X magnification

The photo eyepiece performs the same function as a standard 35mm or Digital SLR camera lens (i.e. focusing the image of the specimen onto the film plane).

3. One of two MA150 series camera attachments:

<b>MA150 / 50</b> Straight-tube camera attachment
<b>MA150 / 60</b> Camera attachment with built-in focusing eyepiece

Note: The MA150 / 60 is provided with a focusing eyepiece viewfinder for framing and parfocalizing the camera attachment to the microscope.



T2 Adapter Ring



Photo Eyepiece



MA150 / 50



MA150 / 60

# DIGITAL CAMERA ADAPTERS

For use with

**NIKON Coolpix 950,990,995 and 5000**

**Olimpus Camedia C-3040Zoom, C-4040Zoom and C-4100**

**Fuji Finepix S602,4900Z, 6900Z**



MA151 / 30 / 50 and optional items of EMZ-8TR and NIKON Coolpix 950



MA 151/30/50



Digital Camera Adapters and Couplers

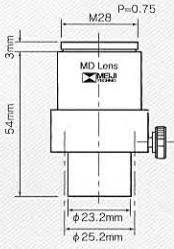
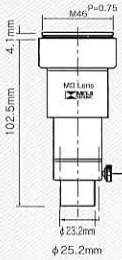
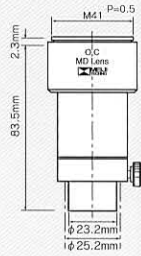
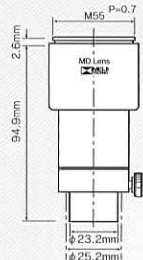
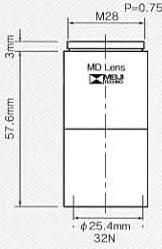
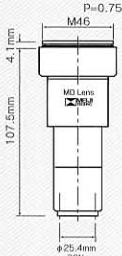
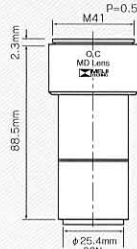
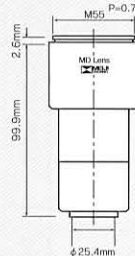
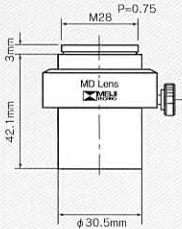
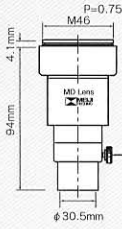
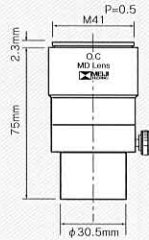
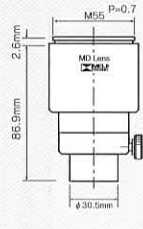

# DIGITAL CAMERA ADAPTERS

DIGITAL CAMERAS MICROSCOPES	NIKON Coolpix 950,990,995	NIKON Coolpix 5000	Olympus Camedia C-3040 Zoom C-4040 Zoom C-4100	Fuji Finepix S602 4900Z, 6900Z
	Cat.No.	Cat.No.	Cat.No.	Cat.No.
<b>Fits a 23.2mm I.D./25.2mm O.D. Eye tube or Photo tube of:</b> EMTR-1, EMTR-2, EMTR-3, EMTR-4, EMZ-2TR, EMZ-5TR, EMZ-5TRD, EMZ-8TR, EMZ-8TRD, EMZ-12TR, EMZ-12TRD,	<b>MA151/30/50</b> 	<b>MA151/30/70</b> 	<b>MA151/30/60</b> 	<b>MA151/30/80</b> 
<b>Fits "C" mount thread, 25.4mm diameter</b> MA151/5N, MA151/35/03, MA151/35/04, MA151/35/15/1, MA151/35/20, MA151/35/25, MA151/8TR, MA151/8TR/02, MA151/10	<b>MA151/40/50</b> 	<b>MA151/40/70</b> 	<b>MA151/40/60</b> 	<b>MA151/40/80</b> 
<b>Fits a 30.5mm I.D./34.0mm O.D. Eye tube of:</b> EMF-1, EMF-2, EMT-1, EMT-2, EMT-3, EMT-4, EMZ-1, EMZ-2, EMZ-5, EMZ-6, EMZ-9, EMZ-10, EMZ-12, Z-7000,	<b>MA151/45/50</b> 	<b>MA151/45/70</b> 	<b>MA151/45/60</b> 	<b>MA151/45/80</b> 

## COUPLERS

### The MA151/37

Digital camera coupler is used in conjunction with the MA151/30/50, MA151/40/50 and MA151/45/50 digital camera adapter. This coupler allows you to convert the M28 x 0.75 thread of the above adaptors to a M37 x 0.75 internal thread.

### MA151/43

Digital camera coupler is used in conjunction with the MA151/30/50, MA151/40/50 and MA151/45/50 digital camera adapter. This coupler allows you to convert the M28 x 0.75 thread of the above adaptors to a M43 x 0.75 internal thread.

## How to use

For photo tube of trinocular head, slip the adapter over the top of the tube and secure it with locking screw.

For eye tube of binocular head, insert the adapter into the eye tube until fully seated and secure the adapter with lock down screw.

For C mount, slip the adapter over the upper part of the C mount adapter and secure it with locking screw.

# EMZ Series OPTICAL DATA

Model	Zoom Range	Auxiliary Lens	SWF10X Eyepieces			SWF12.5X Eyepieces			SWF15X Eyepieces			SWF20X Eyepieces			SWF30X Eyepieces			Working Distance (mm)
			Total Magnification	Field Diameter (mm)	Total Magnification	Field Diameter (mm)	Total Magnification	Field Diameter (mm)	Total Magnification	Field Diameter (mm)	Total Magnification	Field Diameter (mm)	Total Magnification	Field Diameter (mm)	Total Magnification	Field Diameter (mm)		
EMZ-2 EMZ-2TR EMZ-5 EMZ-5TR EMZ-9	0.7X-4.5X	None	7X~45X	32.8~5.1	8.75X~56.25X	28.5~4.4	10.5X~67.5X	22~3.4	14X~90X	16.4~2.5	21X~135X	11~1.7	93					
		0.3X	2.1X~13.5X	109~17	2.62X~16.87X	95~14.6	3.15X~20.25X	73~11.4	4.2X~27X	54.7~8.5	6.3X~40.5X	36.6~5.7	251					
		0.44X	3.08X~19.8X	74.5~11.5	3.85X~24.75X	64.7~10	4.62X~29.7X	50~7.7	6.16X~39.6X	37.2~5.9	9.24X~59.4X	25~3.8	171					
		0.5X	3.5X~22.5X	65.7~10.2	4.37X~28.12X	57~8.8	5.25X~33.75X	44~6.8	7X~45X	32.8~5.1	10.5X~67.5X	22~3.4	148					
		0.75X	5.25X~33.75X	43.8~6.8	6.56X~42.18X	38~5.8	7.87X~50.62X	29.3~4.5	10.5X~67.5X	21.9~3.4	15.75X~101.25X	14.6~2.2	97					
1.5X	10.5X~67.5X	21.9~3.4	13.12X~84.37X	19~2.9	15.75X~101.25X	14.6~2.2	21X~135X	10.9~1.7	31.5X~202.5X	7.3~1.1	49							
2.0X	14X~90X	16.4~2.5	17.5X~112.5X	14.2~2.2	21X~135X	11~1.7	28X~180X	8.2~1.2	42X~270X	5.5~0.8	33							
EMZ-10 Z-7100	0.7X-4.5X	None	7X~45X	32.8~5.1	8.75X~56.25X	28.5~4.4	10.5X~67.5X	22~3.4	14X~90X	16.4~2.6	21X~135X	11~1.7	110					
		0.3X	2.1X~13.5X	109~17	2.62X~16.87X	95~14.6	3.15X~20.25X	73~11.3	4.2X~27X	54.6~8.6	6.3X~40.5X	36.6~5.7	326					
		0.44X	3.08X~19.8X	74.5~11.5	3.85X~24.75X	64.7~10	4.62X~29.7X	50~7.7	6.16X~39.6X	37.2~5.9	9.24X~59.4X	25~3.8	247					
		0.5X	3.5X~22.5X	65.6~10.2	4.37X~28.12X	57~8.8	5.25X~33.75X	44~6.8	7X~45X	32.8~5.1	10.5X~67.5X	22~3.4	194					
		0.75X	5.25X~33.75X	43.8~6.8	6.56X~42.18X	38~5.8	7.87X~50.62X	29.3~4.5	10.5X~67.5X	21.8~3.4	15.75X~101.25X	14.6~2.2	127					
		1.5X	10.5X~67.5X	21.8~3.4	13.12X~84.37X	19~2.9	15.75X~101.25X	14.6~2.2	21X~135X	10.9~1.7	31.5X~202.5X	7.3~1.1	64					
2.0X	14X~90X	16.4~2.5	17.5X~112.5X	14.2~2.2	21X~135X	11~1.7	28X~180X	8.2~1.2	42X~270X	5.5~0.8	44							
EMZ-8TR	0.7X-4.5X	None	7X~45X	32.8~5.1	8.75X~56.25X	28.5~4.4	10.5X~67.5X	22~3.4	14X~90X	16.4~2.6	21X~135X	11~1.7	104					
		0.35X	2.45X~15.75X	93.7~14.5	3.06X~19.68X	81.4~12.5	3.67X~23.62X	62.8~9.7	4.9X~31.5X	46.8~7.4	7.35X~47.25X	31.4~4.8	250					
		0.5X	3.5X~22.5X	65.6~10.2	4.37X~28.12X	57~8.8	5.25X~33.75X	44~6.8	7X~45X	32.8~5.1	10.5X~67.5X	22~3.4	174					
		1.5X	10.5X~67.5X	21.8~3.4	13.12X~84.37X	19~2.9	15.75X~101.25X	14.6~2.2	21X~135X	10.9~1.7	31.5X~202.5X	7.3~1.1	57					
EMZ-12 EMZ-12TR	0.4X-2.5X	None	4X~2.5X	57~9.2	5X~31.2X	50~8	6X~37.5X	38.5~6.1	8X~50X	28.7~4.6	12X~75X	19.2~3	185					
		0.7X	2.8X~17.5X	82.1~13.1	3.5X~21.8X	71.4~11.4	4.2X~26.2X	55~8.8	5.6X~35X	41~6.5	8.4X~46.2X	27.5~4.4	233					
EMZ-13 EMZ-13TR	1.0X-7.0X	None	10X~70X	23.0~3.20	12.5X~87.5X	17.6~2.51	15X~105X	14.66~2.09	20X~140X	11.0~1.57	30X~210X	7.33~1.04	90					
		0.3X	3X~21X	73.33~10.47	3.75X~26.25X	58.6~8.38	4.5X~31.5X	48.88~6.98	6.0X~42.0X	36.6~5.23	9.0X~63.0X	24.44~3.49	230					
		0.44X	4.4X~30.8X	50.0~7.13	5.5X~38.5X	40.0~4.5	6.6X~46.2X	33.1~4.5	8.8X~61.6X	25.0~3.5	13.2X~92.4X	16.5~2.3	167					
		0.5X	5X~35X	44.0~6.28	6.25X~43.75X	35.2~5.02	7.5X~52.5X	29.3~4.19	10.0X~70.0X	22.0~3.14	15.0X~105.0X	14.6~2.09	139					
		0.75X	7.5X~52.5X	29.3~4.19	9.37X~65.62X	23.47~3.35	11.25X~78.75X	19.55~2.79	15.0X~105.0X	14.66~2.09	22.5X~157.5X	9.77~1.39	92					
		1.5X	15.0X~105.0X	14.6~2.09	18.75X~131.25X	11.73~1.67	22.5X~157.5X	9.77~1.39	30.0X~210.0X	7.33~1.04	45.0X~315.0X	4.88~0.69	48					
2.0X	20.0X~140.0X	11.0~1.57	25.0X~175.0X	8.8~1.25	30.0X~210.0X	7.33~1.04	40.0X~280.0X	5.50~0.78	60.0X~420.0X	3.66~0.52	32							



# EMF - EMT - EMTR - EMX OPTICAL DATA

Model	Objectives	Auxiliary Lens	SWF10X Eyepieces			SWF12.5X Eyepieces			SWF15X Eyepieces			SWF20X Eyepieces			SWF30X Eyepieces		
			Total Magnification	Field Diameter (mm)	Total Magnification	Field Diameter (mm)	Total Magnification	Field Diameter (mm)	Total Magnification	Field Diameter (mm)	Total Magnification	Field Diameter (mm)	Total Magnification	Field Diameter (mm)	Total Magnification	Field Diameter (mm)	Working Distance (mm)
EMF-1	1X	None	10X	23	12.5X	20	15X	15.4	20X	11.5	30X	7.7	108				
EMF-2	2X	None	20X	11.5	25X	10	30X	7.7	40X	5.7	60X	3.8	108				
EMT-1 EMTR-1	1X, 2X	None	10X, 20X	23.0, 11.5	12.5X, 25X	20.0, 10.0	15X, 30X	15.3, 7.7	20X, 40X	11.5, 5.8	30X, 60X	7.6, 3.8	108				
		None	10X, 20X	23.0, 11.5	12.5X, 25X	20.0, 10.0	15X, 30X	15.3, 7.7	20X, 40X	11.5, 5.8	30X, 60X	7.6, 3.8	108				
EMT-2 EMTR-2	1X, 3X	None	10X, 30X	23.0, 7.6	12.5X, 37.5X	20.0, 6.6	15X, 45X	15.4, 5.1	20X, 60X	11.5, 3.8	30X, 90X	7.7, 2.5	81				
		0.5X	5X, 15X	46.0, 15.3	6.25X, 18.75X	40.0, 13.0	7.5X, 22.5X	30.8, 10.2	10X, 30X	23.0, 7.6	15X, 45X	15.4, 5.1	108				
		0.75X	7.5X, 22.5X	30.6, 10.22	9.37X, 28.12X	26.6, 8.8	11.25X, 33.75X	20.5, 6.8	15X, 45X	15.3, 5.1	22.5X, 67.5X	10.2, 3.4	72				
		1.5X	15X, 45X	15.3, 5.1	18.75X, 56.25X	13.3, 4.4	22.5X, 67.5X	10.2, 3.4	30X, 90X	7.6, 2.5	45X, 135X	5.1, 1.7	35				
		2.0X	20X, 60X	11.5, 3.8	25X, 75X	10.0, 3.3	30X, 90X	7.7, 2.5	40X, 120X	5.7, 1.9	60X, 180X	3.8, 1.2	21				
EMT-3 EMTR-3	2X, 4X	None	20X, 40X	11.5, 5.7	25X, 50X	10.0, 5.0	30X, 60X	7.7, 3.8	40X, 80X	5.7, 2.8	60X, 120X	3.8, 1.9	63				
		0.5X	10X, 20X	23.0, 11.5	12.5X, 25X	20.0, 10.0	15X, 30X	15.3, 7.6	20X, 40X	11.5, 5.7	30X, 60X	7.6, 3.8	108				
		0.75X	15X, 30X	15.3, 7.6	18.75X, 37.5X	13.3, 6.6	22.5X, 45X	10.2, 5.1	30X, 60X	7.6, 3.8	45X, 90X	5.1, 2.5	72				
		1.5X	30X, 60X	7.7, 3.8	37.5X, 75X	6.6, 3.3	45X, 90X	5.1, 2.5	60X, 120X	3.8, 1.9	90X, 180X	2.5, 1.2	35				
		2.0X	40X, 80X	5.7, 2.8	50X, 100X	5.0, 2.5	60X, 120X	3.8, 1.9	80X, 160X	2.8, 1.4	120X, 240X	1.9, 0.9	22				
EMT-4 EMTR-4	1X, 4X	None	10X, 40X	23.0, 5.7	12.5X, 50X	20.0, 5.1	15X, 65X	15.4, 3.8	20X, 80X	11.5, 2.8	30X, 120X	7.7, 1.9	63				
		0.5X	5X, 20X	46.0, 11.5	6.25X, 25X	38, 9.6	7.5X, 30X	30.8, 7.7	10X, 40X	23.0, 5.7	15X, 60X	15.4, 3.8	108				
		0.75X	7.5X, 30X	30.6, 7.6	9.37X, 37.5X	25.5, 6.5	11.25X, 45X	20.53, 5.1	15X, 60X	15.3, 3.8	22.5X, 90X	10.2, 2.5	72				
		1.5X	15X, 60X	15.3, 3.8	18.75X, 75X	13.1, 3.2	22.5X, 90X	10.2, 2.5	30X, 120X	7.6, 1.9	45X, 180X	5.1, 1.2	35				
		2.0X	20X, 80X	11.5, 2.8	25X, 100X	10.2, 2.3	30X, 120X	7.6, 1.9	40X, 160X	5.7, 1.4	60X, 240X	3.8, 0.9	22				
EMX-1	0.5X, 1.0X	None	5X, 10X	46, 23	6.25X, 12.5X	40.0, 20.0	7.5X, 15X	30.6, 15.3	10X, 20X	23.0, 11.5	15X, 30X	15.3, 7.6	225				
		0.7X	3.5X, 7X	69, 34	4.37X, 8.75X	61, 30	5.25X, 10.5X	48.5, 24	7X, 14X	35, 17.1	10.5X, 21X	22, 11	300				

# EM Series SYSTEM DIAGRAM PART 1

## ZOOM MODELS

Photo/Video attachments are show in Part 4, 5 (Page 41).



### Auxiliary lenses

<b>MA530</b> 0.3X	<b>MA525</b> 0.44X	<b>MA517</b> 0.5X	<b>MA526</b> 0.75X	<b>MA507</b> 1.5X	<b>MA511</b> 2.0X
----------------------	-----------------------	----------------------	-----------------------	----------------------	----------------------

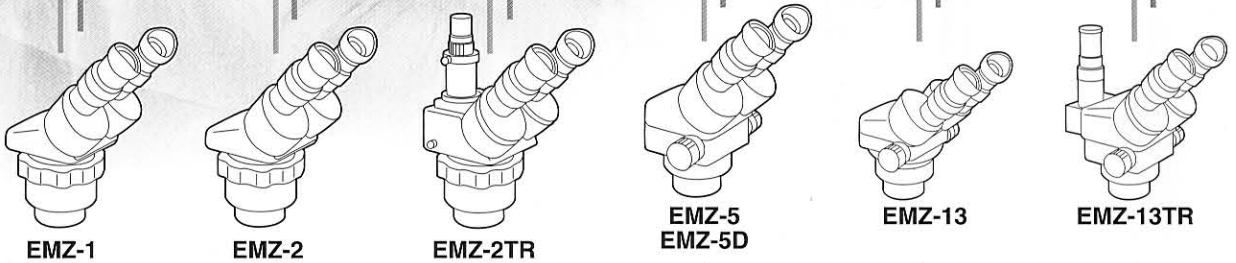

### STAND

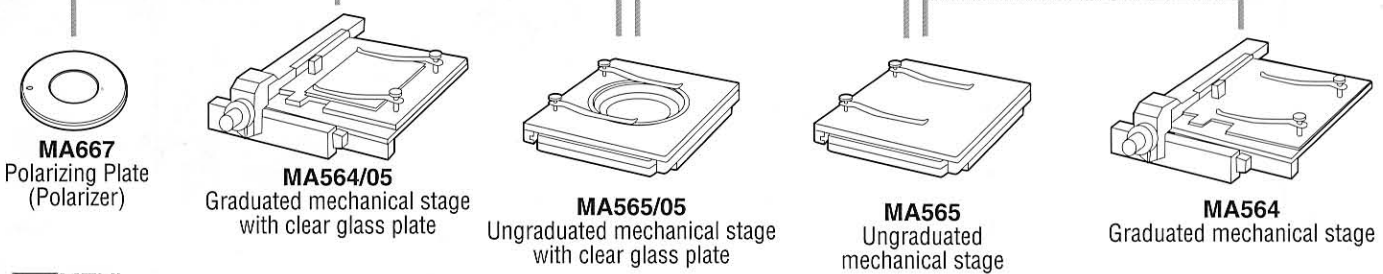
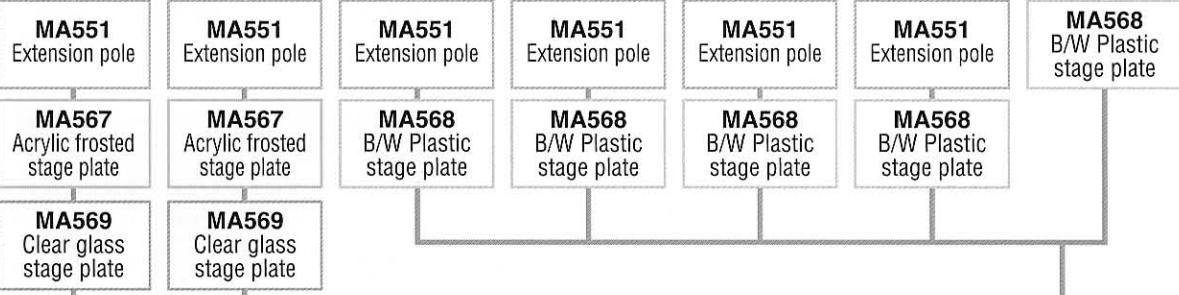
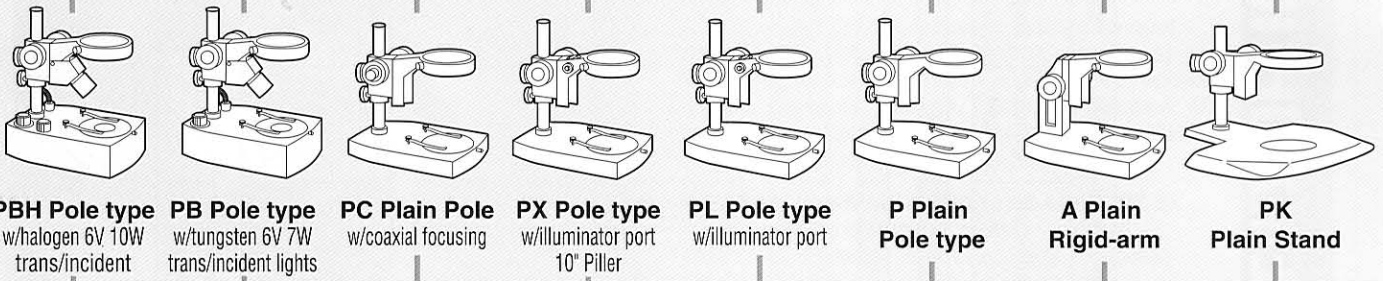



## EYEPIECES, Paired

**MA501**  
SWF5X

**MA502**  
SWF10X

**MA520**  
SWF12.5X

**MA503**  
SWF15X

**MA535**  
HSWF15X

**MA504**  
SWF20X

**MA521**  
SWF30X

**MA519\***  
SWF10X-F  
\*(Piece)

**MA600**  
EYESHIELD

### Auxiliary lenses

**MA791** 0.28X  
**MA792** 0.35X  
**MA794** 0.5X  
**MA795** 1.5X

### Auxiliary lenses

**MA545** 0.3X  
**MA558** 0.44X  
**MA546** 0.5X  
**MA547** 0.75X  
**MA548** 1.5X  
**MA549** 2.0X

### Auxiliary lenses

**MA652** 0.7X  
**MA796** 0.57X

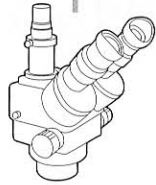

**EMZ-5TR**  
**EMZ-5TRD**

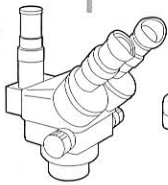

**EMZ-8TR**  
**EMZ-8TRD**

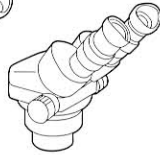

**EMZ-6**

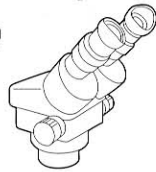

**EMZ-9**

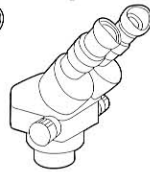

**EMZ-10**



**Z-7100**

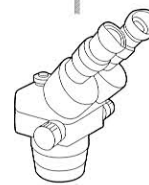

**EMZ-12**  
**EMZ-12D**

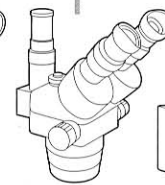

**EMZ-12TR**  
**EMZ-12TRD**

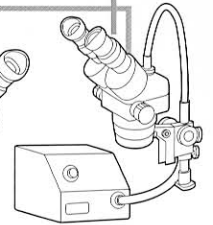

**EMZ-12**  
**FL150 and FL150/12**

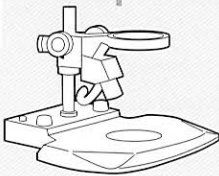

**PKL**  
**LED Stand**

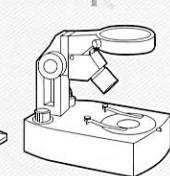

**ABZ Rigid-arm**  
w/tungsten 6V 7W  
trans/incident lights

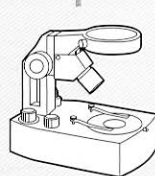

**ABZH Rigid-arm**  
w/halogen 6V 10W  
trans/incident lights



**ABE Extendable**  
w/halogen 6V 10W  
trans/incident lights

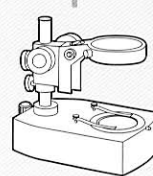

**BX Stand**  
w/mirror for B/D  
(light not included)

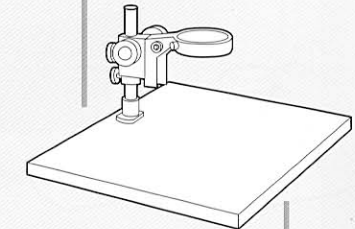

**KBL Pole type**  
w/illuminator port  
on flat base

**MA551**  
Extension pole

**MA567**  
Acrylic frosted  
stage plate

**MA569**  
Clear glass  
stage plate

**MA567**  
Acrylic frosted  
stage plate

**MA569**  
Clear glass  
stage plate

**MA567**  
Acrylic frosted  
stage plate

**MA569**  
Clear glass  
stage plate

**MA551**  
Extension pole

**MA567**  
Acrylic frosted  
stage plate

**MA569**  
Clear glass  
stage plate

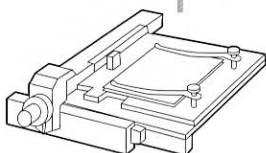

**MA564/05**  
Graduated mechanical stage  
with clear glass plate



**MA565/05**  
Ungraduated mechanical stage  
with clear glass plate



**MA667**  
Polarizing Plate  
(Polarizer)

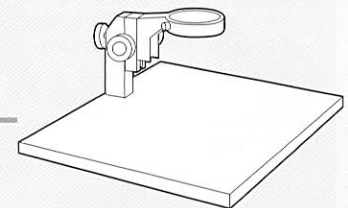

**KBE Rigid-extendable**  
arm on flat base

# EM Series SYSTEM DIAGRAM PART 2

## EMF, EMT, EMTR, EMX

Photo/Video attachments are show in Part 4, 5 (Page 41).

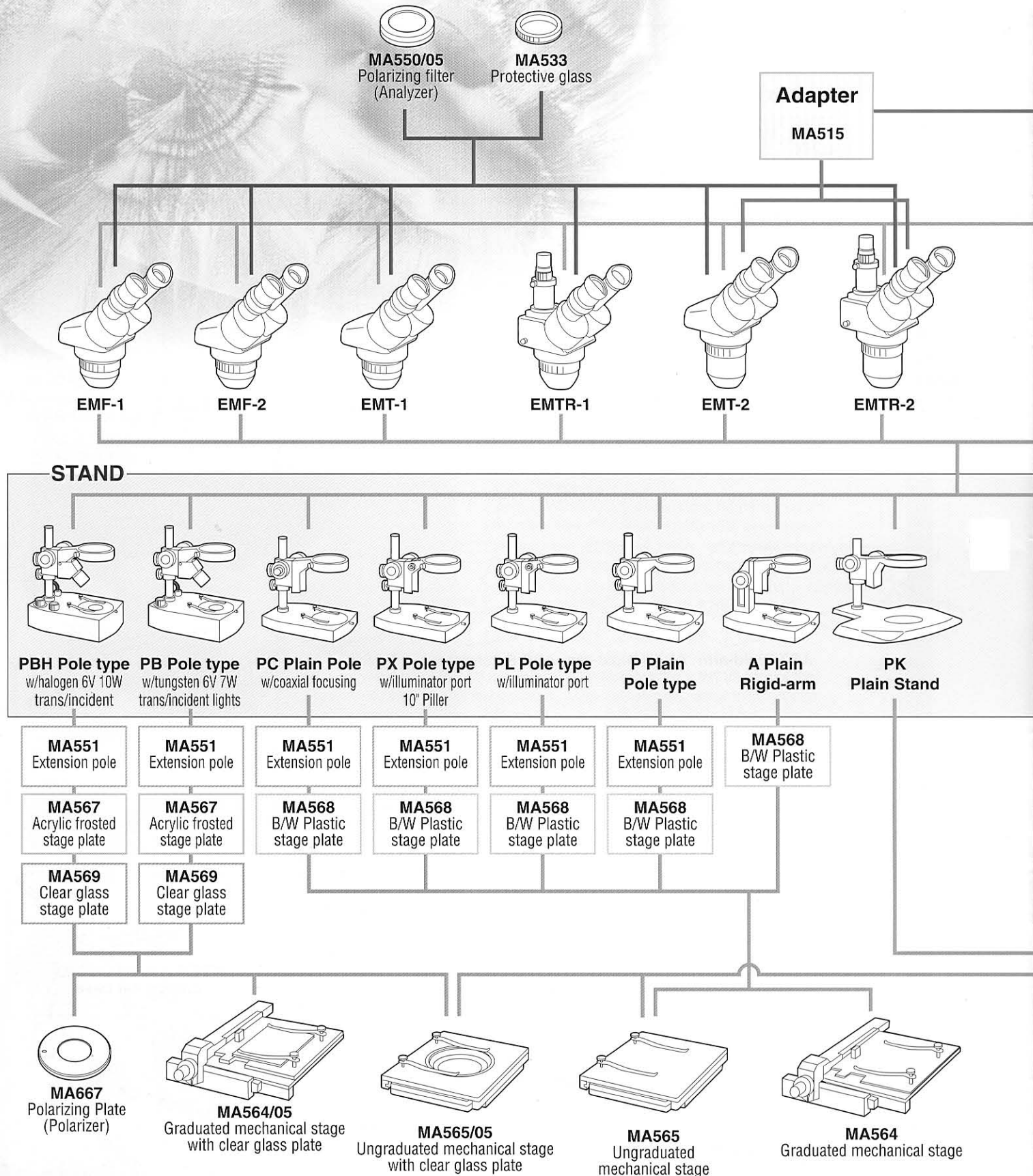



## EYEPIECES, Paired

**MA501**  
SWF5X

**MA502**  
SWF10X

**MA520**  
SWF12.5X

**MA503**  
SWF15X

**MA535**  
HSWF15X

**MA504**  
SWF20X

**MA521**  
SWF30X

**MA519\***  
SWF10X-F  
\*(Piece)

**MA600**  
EYESHIELD

## Auxiliary lenses

**MA518**  
0.5X

**MA527**  
0.75X

**MA513**  
1.5X

**MA514**  
2.0X

**MA550/10**  
Polarizing filter  
(Analyzer)

**MA537**  
Protective glass

## Auxiliary lens

**MA658**  
Protective glass

**MA652**  
0.7X

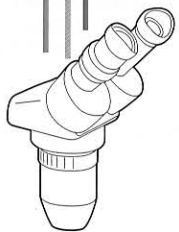

**EMT-3**

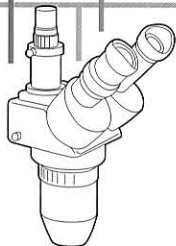

**EMTR-3**

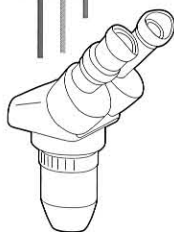

**EMT-4**

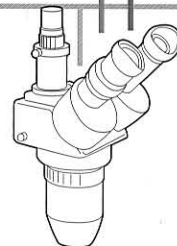

**EMTR-4**

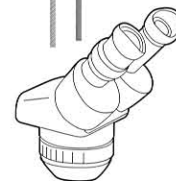

**EMX\***

\*Need to use PX stand or Pole type stand with MA551 Extension pole.

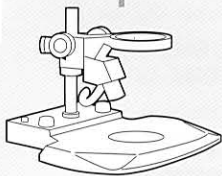

**PKL**  
LED Stand



**ABZ Rigid-arm**  
w/tungsten 6V 7W  
trans/incident lights



**ABZH Rigid-arm**  
w/halogen 6V 10W  
trans/incident lights



**ABE Extendable**  
w/halogen 6V 10W  
trans/incident lights

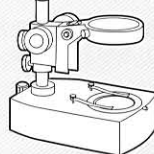

**BX Stand**  
w/mirror for B/D  
(light not included)

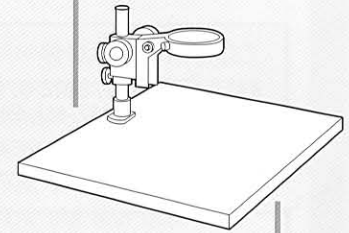

**KBL Pole type**  
w/illuminator port  
on flat base

**MA551**  
Extension pole

**MA567**  
Acrylic frosted  
stage plate

**MA569**  
Clear glass  
stage plate

**MA567**  
Acrylic frosted  
stage plate

**MA569**  
Clear glass  
stage plate

**MA567**  
Acrylic frosted  
stage plate

**MA569**  
Clear glass  
stage plate

**MA551**  
Extension pole

**MA567**  
Acrylic frosted  
stage plate

**MA569**  
Clear glass  
stage plate

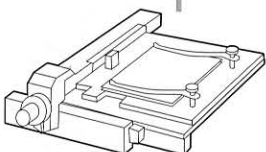

**MA564/05**  
Graduated mechanical stage  
with clear glass plate



**MA565/05**  
Ungraduated mechanical stage  
with clear glass plate



**MA667**  
Polarizing Plate  
(Polarizer)

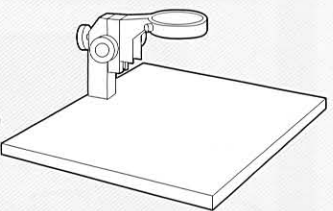

**KBE Rigid-extendable  
arm on flat base**

# EM Series SYSTEM DIAGRAM PART 3

## SPECIAL STANDS

### ZOOM HEADS

EMZ-1, EMZ-2, EMZ-5, EMZ-5D, EMZ-6, EMZ-9, EMZ-10, Z-7100, EMZ-2TR, EMZ-5TR, EMZ-5TRD, EMZ-8TR, EMZ-8TRD, EMZ-8U, EMZ-8UD, EMZ-8TRU, EMZ-12, EMZ-12D, EMZ12TR, EMZ-12TRD, EMZ-13, EMZ-13TR

EMF, EMT VIEWING HEADS: EMF-1, EMF-2, EMT-1, EMT-2, EMT-3, EMT-4, EMTR-1, EMTR-2, EMTR-3, EMTR-4,

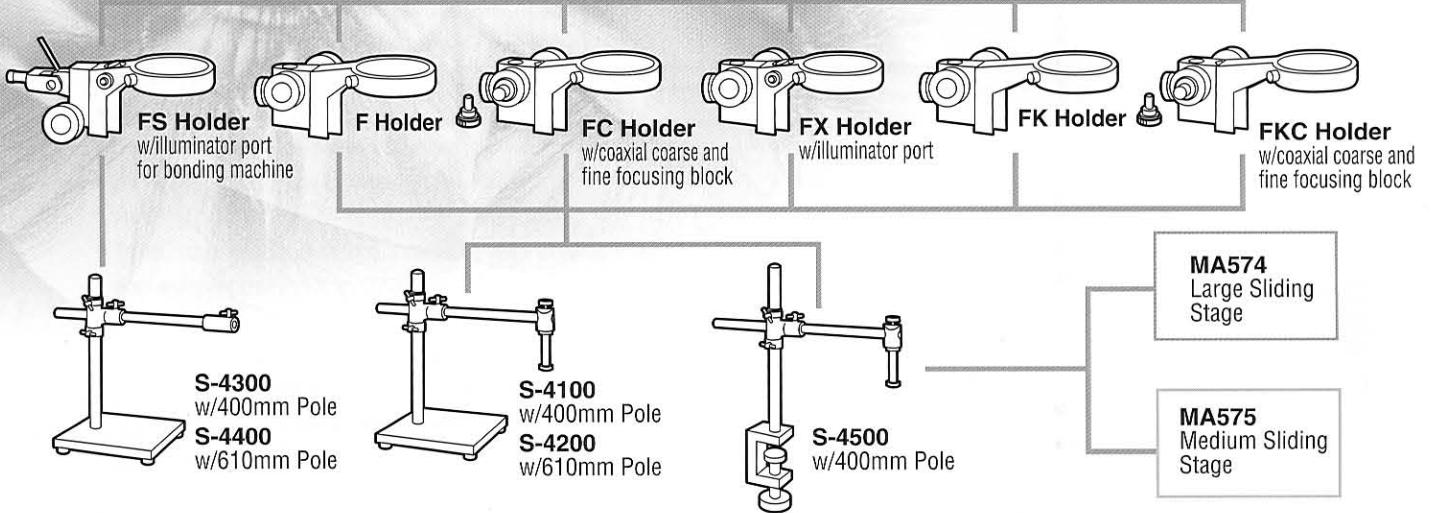

### ZOOM HEADS

EMZ-1, EMZ-2, EMZ-5, EMZ-5D, EMZ-6, EMZ-9, EMZ-10, Z-7100, EMZ-2TR, EMZ-5TR, EMZ-5TRD, EMZ-8TR, EMZ-8TRD, EMZ-8U, EMZ-8UD, EMZ-8TRU, EMZ-12, EMZ-12D, EMZ12TR, EMZ-12TRD, EMZ-13, EMZ-13TR

EMF, EMT VIEWING HEADS: EMF-1, EMF-2, EMT-1, EMT-2, EMT-3, EMT-4, EMTR-1, EMTR-2, EMTR-3, EMTR-4,

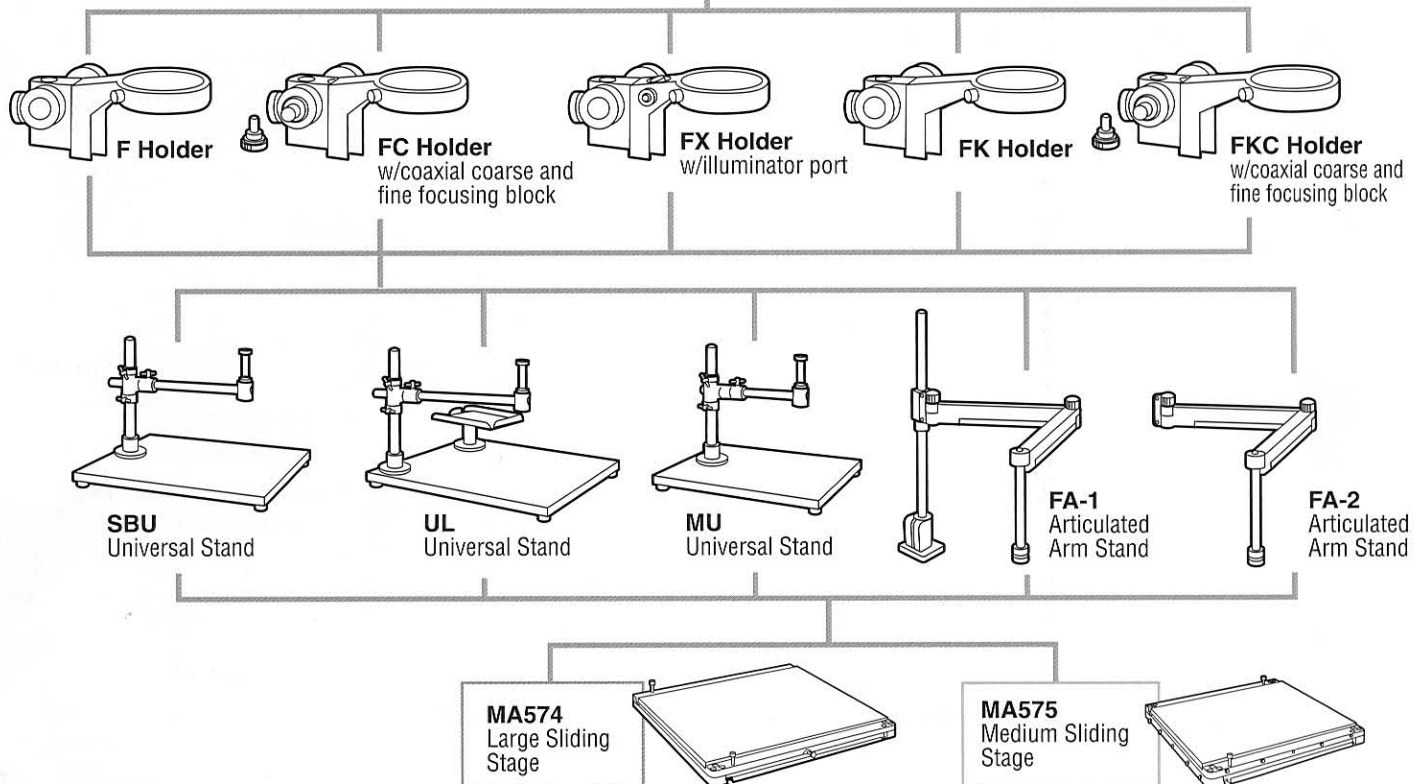



# EM Series SYSTEM DIAGRAM PART 4 VIDEO MICROSCOPY

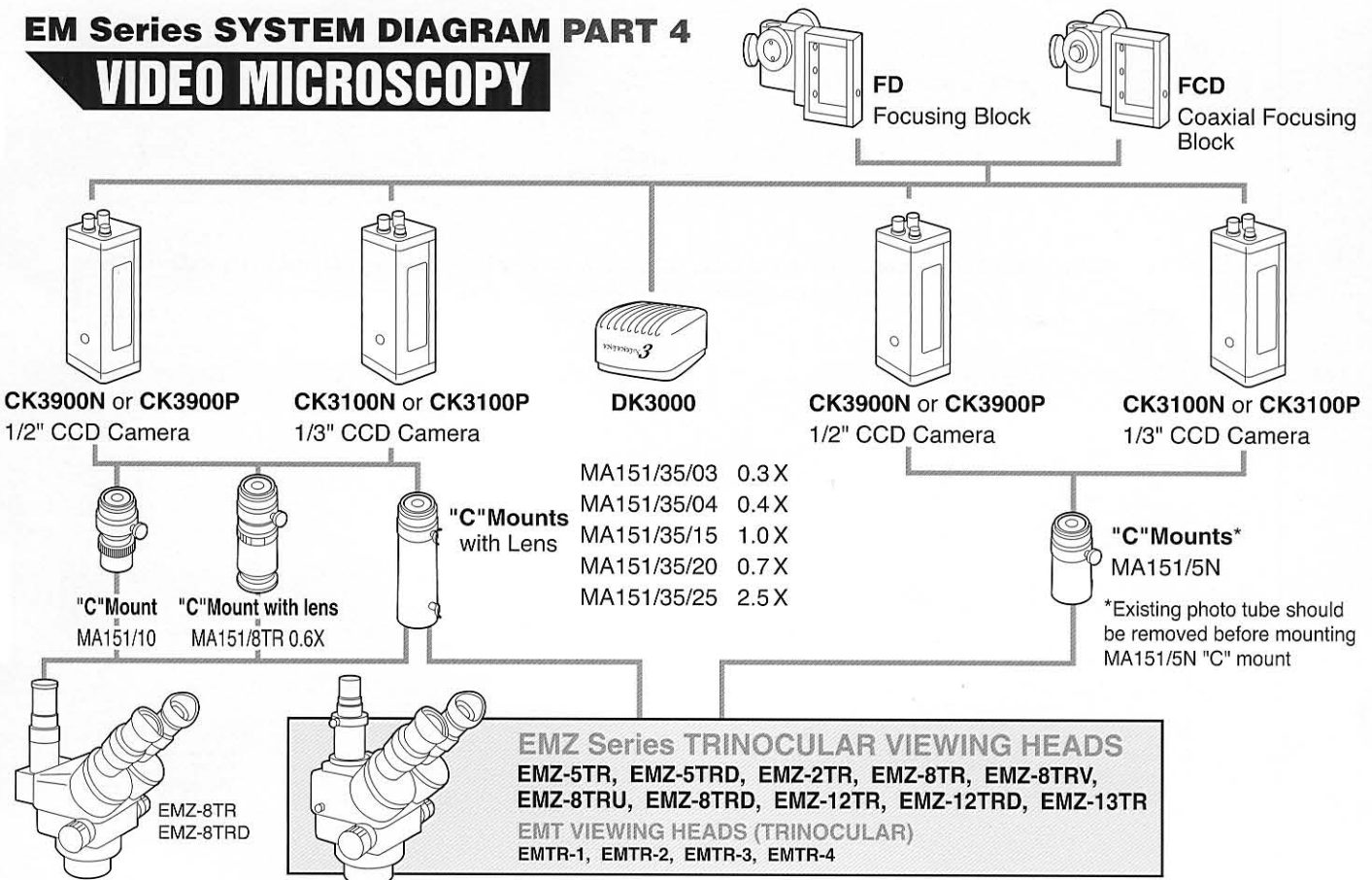

# EM Series SYSTEM DIAGRAM PART 5 PHOTO MICROSCOPY

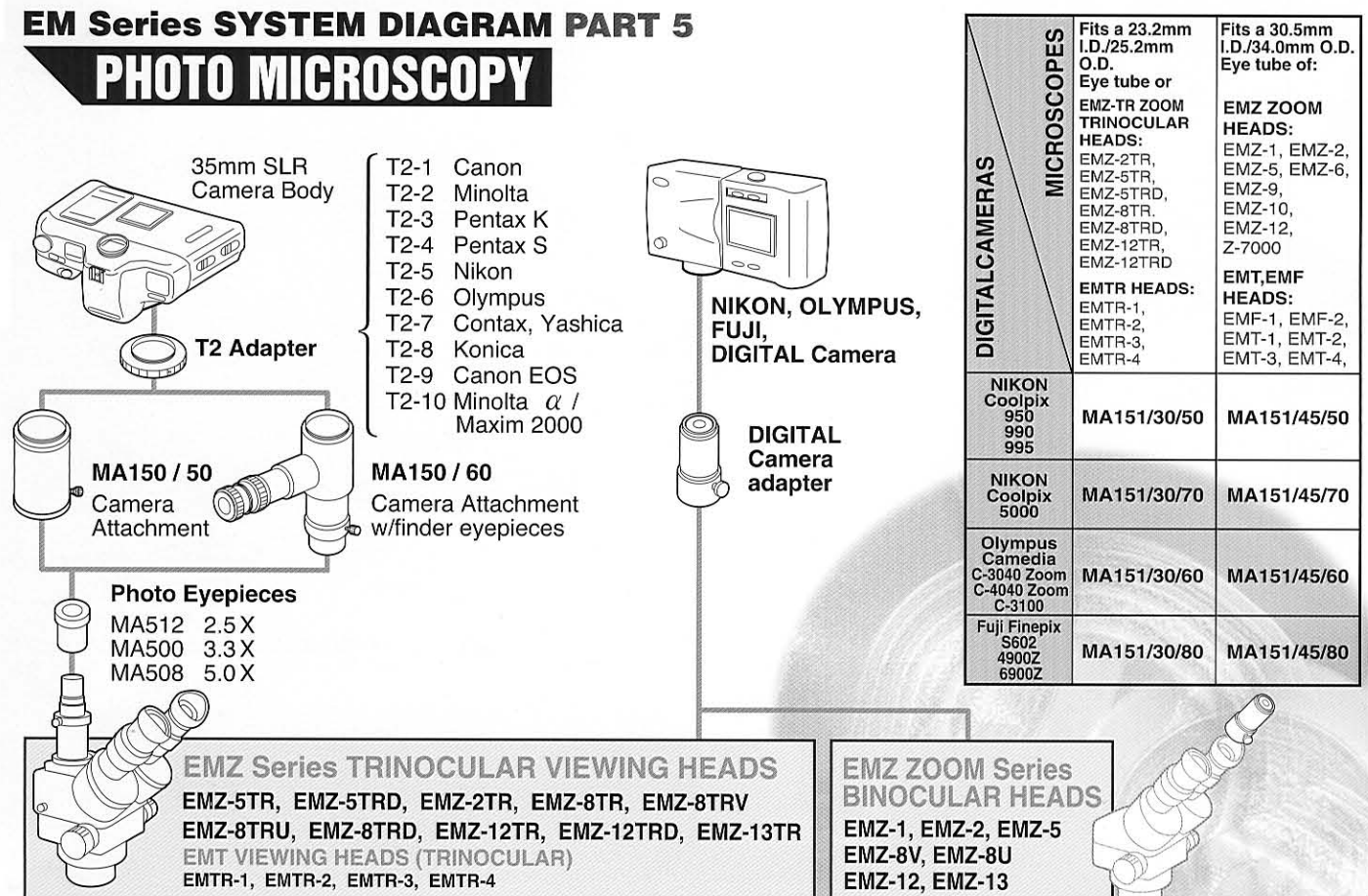

DIGITAL CAMERAS	MICROSCOPES	Fits a 23.2mm I.D./25.2mm O.D.	Fits a 30.5mm I.D./34.0mm O.D.
		Eye tube or EMZ-TR ZOOM TRINOCULAR HEADS: EMZ-2TR, EMZ-5TR, EMZ-5TRD, EMZ-8TR, EMZ-8TRD, EMZ-12TR, EMZ-12TRD	EMZ ZOOM HEADS: EMZ-1, EMZ-2, EMZ-5, EMZ-6, EMZ-9, EMZ-10, EMZ-12, Z-7000 EMT, EMF HEADS: EMF-1, EMF-2, EMT-1, EMT-2, EMT-3, EMT-4
NIKON Coolpix 950, 990, 995		MA151/30/50	MA151/45/50
NIKON Coolpix 5000		MA151/30/70	MA151/45/70
Olympus Camera C-3040 Zoom, C-4040 Zoom, C-3100		MA151/30/60	MA151/45/60
Fuji Finepix S602, 4900Z, 6900Z		MA151/30/80	MA151/45/80



## MEIJI TECHNO CO.,LTD.

322-1,Chikumazawa, Miyoshi-machi, Iruma-gun  
Saitama 354-0043, Japan

Tel : (0)49-259-0111 Fax : (0)49-259-0113

E-mail : [meiji@meijitechno.co.jp](mailto:meiji@meijitechno.co.jp)

<http://www.meijitechno.co.jp>

## MEIJI TECHNO AMERICA

3010 Olcott Street, Santa Clara, CA 95054, USA

Tel : 408-970-4799 Fax : 408-970-5054

Toll free : 1-800-832-0060

E-mail : [sales@meijitechno.com](mailto:sales@meijitechno.com)

<http://www.meijitechno.com>



Specifications and design subject to change without notice for improvements

'06. 02. 287. 20,000 V5 Printed in Japan